



TEST REPORT

Applicant	Shenzhen SOFARSOLAR Co., Ltd.
Address	3A-1, Huake Building, East Technology Park, Qiaoxiang Road, Nanshan District, Shenzhen, China.

Manufacturer or Supplier	Shenzhen SOFARSOLAR Co., Ltd.	
Address	3A-1, Huake Building, East Technology Park, Qiaoxiang Road, Nanshan District, Shenzhen, China.	
Product	PV grid-interactive inverter	
Brand Name		
Model	SOFAR 3000TL, SOFAR 1100TL, SOFAR 2200TL	
Additional Model & Model Difference	SOFAR 1600TL, SOFAR 2700TL See item 2.1	
Date of tests	May 08, 2014 ~ Jun. 30, 2014	

The submitted sample of the above equipment has been tested for according to following European Directive - Electromagnetic directive 2004/108/EC and the tests have been carried out according to the requirements of the following standards:

- EN 61000-6-3:2007 + A1:2011
- EN 61000-3-2:2006 + A1:2009 + A2:2009
- EN 61000-3-3:2013
- EN 61000-6-2:2005

CONCLUSION: The submitted sample was found to COMPLY with the test requirement

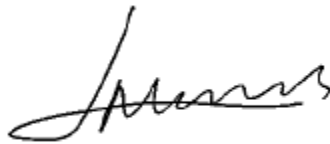
Tested by Breeze Jiang Project Engineer / EMC Department	Approved by Madison Luo Manager / EMC Department
	
	Date: Jul. 21, 2014

This report is for your exclusive use. Any copying or replication of this report to or for any other person or entity, or use of our name or trademark, is permitted only with our prior written permission. This report sets forth our findings solely with respect to the test samples identified herein. The results set forth in this report are not indicative or representative of the quality or characteristics of the lot from which a test sample was taken or any similar or identical product unless specifically and expressly noted. Our report includes all of the tests requested by you and the results thereof based upon the information that you provided to us. You have 60 days from date of issuance of this report to notify us of any material error or omission caused by our negligence, provided, however, that such notice shall be in writing and shall specifically address the issue you wish to raise. A failure to raise such issue within the prescribed time shall constitute your unqualified acceptance of the completeness of this report, the tests conducted and the correctness of the report contents. Unless specific mention, the uncertainty of measurement has been explicitly taken into account to declare the compliance or non-compliance to the specification



Table of Contents

RELEASE CONTROL RECORD 5

1 SUMMARY OF TEST RESULTS 6

1.1 MEASUREMENT UNCERTAINTY 8

2 GENERAL INFORMATION 9

2.1 GENERAL DESCRIPTION OF EUT 9

2.2 DESCRIPTION OF TEST MODES 11

2.3 GENERAL DESCRIPTION OF APPLIED STANDARDS 12

2.4 DESCRIPTION OF SUPPORT UNITS 12

3 EMISSION TEST 13

3.1 CONDUCTED EMISSION MEASUREMENT 13

3.1.1 LIMITS OF CONDUCTED EMISSION MEASUREMENT 13

3.1.2 TEST INSTRUMENTS 13

3.1.3 TEST PROCEDURE 14

3.1.4 DEVIATION FROM TEST STANDARD 14

3.1.5 TEST SETUP 15

3.1.6 EUT OPERATING CONDITIONS 15

3.1.7 TEST RESULTS 16

3.2 RADIATED EMISSION MEASUREMENT 18

3.2.1 LIMITS OF RADIATED EMISSION MEASUREMENT 18

3.2.2 TEST INSTRUMENTS 19

3.2.3 TEST PROCEDURE 20

3.2.4 DEVIATION FROM TEST STANDARD 21

3.2.5 TEST SETUP 22

3.2.6 EUT OPERATING CONDITIONS 22

3.2.7 TEST RESULTS 23

3.3 HARMONICS CURRENT MEASUREMENT (<16A) 25

3.3.1 LIMITS OF HARMONICS CURRENT MEASUREMENT 25

3.3.2 TEST INSTRUMENTS 26

3.3.3 TEST PROCEDURE 26

3.3.4 DEVIATION FROM TEST STANDARD 27

3.3.5 TEST SETUP 27

3.3.6 EUT OPERATING CONDITIONS 27

3.3.7 TEST RESULTS 28

3.4 VOLTAGE FLUCTUATION AND FLICKS MEASUREMENT 32

3.4.1 LIMITS OF VOLTAGE FLUCTUATION AND FLICKS MEASUREMENT 32

3.4.2 TEST INSTRUMENTS 32

3.4.3 TEST PROCEDURE 32

3.4.4 DEVIATION FROM TEST STANDARD 33

3.4.5 TEST SETUP 33

3.4.6 EUT OPERATING CONDITIONS 33

3.4.7 TEST RESULTS 34

4 IMMUNITY TEST 36

4.1 GENERAL DESCRIPTION 36



4.1.1 GENERAL DESCRIPTION OF EN 61000-6-236

4.1.2 PERFORMANCE CRITERIA37

4.1.3 EUT OPERATING CONDITION.....37

4.2 ELECTROSTATIC DISCHARGE IMMUNITY TEST (ESD).....38

4.2.1 TEST SPECIFICATION38

4.2.2 TEST INSTRUMENTS.....38

4.2.3 TEST PROCEDURE.....39

4.2.4 DEVIATION FROM TEST STANDARD.....39

4.2.5 TEST SETUP.....40

4.2.6 TEST RESULTS41

4.3 RADIATED, RADIO-FREQUENCY, ELECTROMAGNETIC FIELD.....42

IMMUNITY TEST (RS).....42

4.3.1 TEST SPECIFICATION42

4.3.2 TEST INSTRUMENTS.....42

4.3.3 TEST PROCEDURE.....43

4.3.4 DEVIATION FROM TEST STANDARD.....43

4.3.5 TEST SETUP.....44

4.3.6 TEST RESULTS45

4.4 ELECTRICAL FAST TRANSIENT/BURST IMMUNITY TEST (EFT).....46

4.4.1 TEST SPECIFICATION46

4.4.2 TEST INSTRUMENTS.....46

4.4.3 TEST PROCEDURE.....46

4.4.4 DEVIATION FROM TEST STANDARD.....46

4.4.5 TEST SETUP.....47

4.4.6 TEST RESULTS48

4.5 SURGE IMMUNITY TEST49

4.5.1 TEST SPECIFICATION49

4.5.2 TEST INSTRUMENTS.....49

4.5.3 TEST PROCEDURE.....50

4.5.4 DEVIATION FROM TEST STANDARD.....50

4.5.5 TEST SETUP.....50

4.5.6 TEST RESULTS51

4.6 IMMUNITY TO CONDUCTED DISTURBANCES INDUCED BY RF.....52

FIELDS (CS).....52

4.6.1 TEST SPECIFICATION52

4.6.2 TEST INSTRUMENTS.....52

4.6.3 TEST PROCEDURE.....53

4.6.4 DEVIATION FROM TEST STANDARD.....53

4.6.5 TEST SETUP.....54

4.6.6 TEST RESULTS55

4.7 POWER FREQUENCY MAGNETIC FIELD IMMUNITY TEST56

4.7.1 TEST SPECIFICATION56

4.7.2 TEST INSTRUMENTS.....56

4.7.3 TEST PROCEDURE.....56

4.7.4 DEVIATION FROM TEST STANDARD.....56

4.7.5 TEST SETUP.....57

4.7.6 TEST RESULTS58

5 PHOTOGRAPHS OF THE TEST CONFIGURATION 59



**BUREAU
VERITAS**

Test Report No.: CE140508N005R1

6	APPENDIX A – MODIFICATIONS RECORDERS FOR ENGINEERING CHANGES TO THE EUT BY THE LAB	66
----------	---	-----------



**BUREAU
VERITAS**

Test Report No.: CE140508N005R1

RELEASE CONTROL RECORD

ISSUE NO.	REASON FOR CHANGE	DATE ISSUED
CE140508N005	Original release	Jul. 10, 2014
CE140508N005R1	Based on the original report CE140508N005 change power supply information, model and technical characteristics.	Jul. 21, 2014



1 SUMMARY OF TEST RESULTS

The EUT has been tested according to the following specifications:

EMISSION			
Standard	Test Type	Result	Remarks
EN61000-6-3:2007+ A1:2011	Conducted test	PASS	Meets requirement limit Minimum passing margin is -3.00 dB at 0.36094MHz
	Radiated test (30MHz~1GHz)	PASS	Meets limits minimum passing margin is -5.08 dB at 191.02MHz
EN 61000-3-2:2006 + A1:2009 + A2:2009	Harmonic current emissions	PASS	Meets the requirements.
EN 61000-3-3:2013	Voltage fluctuations & flicker	PASS	Meets the requirements.



IMMUNITY (EN 61000-6-2:2005)			
Standard	Test Type	Result	Remarks
IEC 61000-4-2:2008	Electrostatic discharge immunity test	PASS	Electrostatic Discharge – ESD: 8kV Air discharge, 4kV Contact discharge, Performance Criterion A
IEC 61000-4-3:2005 + A1:2007+A2:2010	Radiated, radio-frequency, electromagnetic field immunity test	PASS	Radio-Frequency Electromagnetic Field Susceptibility Test – RS: 80-1000 MHz, 10V/m, 80% AM (1kHz), 1400-2000 MHz, 3V/m, 80% AM (1kHz) 2000-2700 MHz, 1V/m, 80% AM (1kHz) Performance Criterion A
IEC 61000-4-4:2012	Electrical fast transient / burst immunity test.	PASS	Electrical Fast Transient/Burst - EFT AC Power line: 2kV, DC Power line: 2kV, Performance Criterion A
IEC 61000-4-5:2005	Surge immunity test	PASS	Surge Immunity Test: 1.2/50 us Open Circuit Voltage, 8 /20 us Short Circuit Current, AC Power Line: line to line 1 kV, Line to earth 2kV , DC Power Line: line to line 0.5 kV Performance Criterion B
IEC 61000-4-6:2008	Immunity to conducted disturbances, induced by radio-frequency fields	PASS	Conducted Radio Frequency Disturbances Test – CS: 0.15-80 MHz, 10Vrms, 80% AM, 1kHz, Performance Criterion A
IEC 61000-4-8:2009	Power frequency magnetic field immunity test.	PASS	Power Frequency Magnetic Field Test, 50 Hz / 60Hz, 30A/m, Performance Criterion A



1.1 MEASUREMENT UNCERTAINTY

Where relevant, the following measurement uncertainty levels have been estimated for tests performed on the EUT as specified in CISPR 16-4-2:

This uncertainty represents an expanded uncertainty expressed at approximately the 95% confidence level using a coverage factor of $k=2$.

MEASUREMENT	FREQUENCY	UNCERTAINTY
Mains Terminal Disturbance Voltage Test	0.15MHz ~ 30MHz	+ /-2.67 dB
Radiated Disturbance Test	30MHz ~ 1000MHz	+ /-4.36 dB



2 GENERAL INFORMATION

2.1 GENERAL DESCRIPTION OF EUT

PRODUCT	PV Grid Inverter
MODEL NO.	SOFAR 3000TL, SOFAR 1100TL, SOFAR 2200TL
ADDITIONAL MODEL	SOFAR 1600TL, SOFAR 2700TL
POWER SUPPLY	DC Input: DC 110 - 380V Max. 10A For SOFAR 1100TL; DC Input: DC 165 - 380V Max. 10A For SOFAR 1600TL ; DC Input: DC 170 - 450V Max. 13A For SOFAR 2200TL; DC Input: DC 210 - 450V Max. 13A For SOFAR 2700TL; DC Input: DC 230 - 450V Max. 13A For SOFAR 3000TL Output: AC 230V, 50/60Hz, Power: 1000W / 1500W / 2000W / 2500W / 2800W Output Voltage/Current: SOFAR 1100TL:230V/4.5A; SOFAR 1600TL:230V/7.0A; SOFAR 2200TL:230V/9.5A; SOFAR 2700TL:230V/11.5A; SOFAR 3000TL:230V/13.0A
SOFTWARE VERSION	V1.00
HARDWARE VERSION	V1.00
THE HIGHEST OPERATING FREQUENCY	Below 108MHz
DATA CABLE SUPPLIED	DC Cable: Shielded; Detachable 1.8m; AC Cable: Shielded; Detachable 1.8m

NOTE:

1. This report CE140508N005R1 supersedes the previous one with the report number CE140508N005 dated on Jul. 10, 2014.
2. For the test results, the EUT had been tested with all conditions. But only the worst case was showed in test report.
3. For a more detailed features description, please refer to the manufacturer's specifications or the User's Manual.
4. RS485 port on the product is for client to collect data, according to client requirements, no need to test.
5. All models shell include red, blue, white and other colors. All models of DC switch and WIFI module is optional accessories, optional installation according to the need of client.



6. This is a series of PV Grid Inverter with the same as in hardware except the amount of BUS capacitor, inverter inductor, Boost and IGBT component and DC switch are different. Identical in software the output power just adjusted by software; models SOFAR 3000TL, SOFAR 1100TL, SOFAR 2200TL are selected to test. full test was performed for the model SOFAR 3000TL, and partial test for the models SOFAR 1100TL, SOFAR 2200TL.

Ratings	SOFAR 1100TL	SOFAR 1600TL	SOFAR 2200TL	SOFAR 2700TL	SOFAR 3000TL
MPP DC voltage range [V]	110-380	165-380	170-450	210-450	230-450
Input DC voltage range [V]	90-400, max. 450		100-480, max. 500		
Input DC current [A]	10		13		
Output AC voltage [V]	230V, 50Hz				
Output AC current [A]	4,5	7,0	9,5	11,5	13,0
Output power [W]	1000	1500	2000	2500	2800

7. Model Difference:

Difference:	SOFAR 3000TL	SOFAR 2700TL	SOFAR 2200TL	SOFAR 1600TL	SOFAR 1100TL
Boost inductor	1.9mH	1.9mH	1.9mH	2.6mH	2.6mH
Input sampling resistor (RP105,RP108 /RP189,RP109)	200ohm / 7.5Kohm	200ohm / 7.5Kohm	200ohm / 7.5Kohm	220ohm / 10Kohm	220ohm / 10Kohm
Bus capacitor	3pcs	3pcs	3pcs	2pcs	2pcs
Inverter inductor	1.3mH	1.5mH	2.1mH	2.3mH	3.4mH
Output sampling resistor (RP118, RP119, RC18 /RP120, RP121,RC22)	2Kohm,100ohm,100ohm	2Kohm,100ohm,100ohm	1.0Kohm,330ohm,330ohm	1.0Kohm,200ohm,100ohm	499ohm,200ohm,200ohm



2.2 DESCRIPTION OF TEST MODES

The EUT was tested under the following modes' the final worst mode were marked in boldface and recorded in this report.

◆ For Conducted Emission Test

Test Mode	TEST VOLTAGE	Model
Full Load	DC 380V	SOFAR 2200TL
Full Load	DC 380V	SOFAR 1100TL
Full Load	DC 230V	SOFAR 3000TL
Full Load	DC 360V	
Full Load	DC 450V	

◆ For Radiated Emission Test

Test Mode	TEST VOLTAGE	Model
Full Load	DC 380V	SOFAR 2200TL
Full Load	DC 380V	SOFAR 1100TL
Full Load	DC 230V	SOFAR 3000TL
Full Load	DC 360V	
Full Load	DC 450V	

◆ For Harmonics and Flicker Tests

Test Mode	TEST VOLTAGE	Model
Full Load	DC 380V	SOFAR 1100TL
Full Load	DC 380V	SOFAR 3000TL

◆ For Immunity Test

Test Mode	TEST VOLTAGE	Model
10% Load	DC 300V	SOFAR 3000TL



2.3 GENERAL DESCRIPTION OF APPLIED STANDARDS

The EUT has been tested and complied with the requirements of the following standards:

- EN 61000-6-3:2007 + A1:2011**
- EN 61000-3-2:2006 + A1:2009 + A2:2009**
- EN 61000-3-3:2013**
- EN 61000-6-2:2005**
- IEC 61000-4-2:2008
- IEC 61000-4-3:2005 + A1:2007 + A2:2010
- IEC 61000-4-4:2012
- IEC 61000-4-5:2005
- IEC 61000-4-6:2008
- IEC 61000-4-8:2009

Notes: The above IEC basic standards are applied with latest version if customer has no special requirement

2.4 DESCRIPTION OF SUPPORT UNITS

The EUT has been tested as an independent unit together with other necessary accessories or support units. The following support units or accessories were used to form a representative test configuration during the tests.

NO.	PRODUCT	BRAND	MODEL NO.	SERIAL NO.	FCC ID
1	DC Source	Chroma	62150H-1000S	62150EF00488	N/A

NO.	SIGNAL CABLE DESCRIPTION OF THE ABOVE SUPPORT UNITS
1	AC Line: Unshielded, Detachable 2.0m, DC Line: Unshielded, Detachable 2.0m;



3 EMISSION TEST

3.1 CONDUCTED EMISSION MEASUREMENT

3.1.1 LIMITS OF CONDUCTED EMISSION MEASUREMENT

FREQUENCY (MHz)	Class A (dBuV)		Class B (dBuV)	
	Quasi-peak	Average	Quasi-peak	Average
0.15 - 0.5	79	66	66 - 56	56 - 46
0.50 - 5.0	73	60	56	46
5.0 - 30.0	73	60	60	50

- Note:**
- (1) The lower limit shall apply at the transition frequencies.
 - (2) The limit decreases in line with the logarithm of the frequency in the range of 0.15 to 0.50 MHz.
 - (3) All emanations from a class A/B digital device or system, including any network of conductors and apparatus connected thereto, shall not exceed the level of field strengths specified above.

3.1.2 TEST INSTRUMENTS

Equipment	Manufacturer	Model No.	Serial No.	Last Cal.	Next Cal.
EMI Test Receiver	Rohde&Schwarz	ESCS30	100199	May 17,14	May 16,15
Pulse Limiter	Rohde&Schwarz	ESH3-Z2	100168	Oct. 12,13	Oct. 11,14
Artificial Mains Network	Rohde&Schwarz	ESH2-Z5	100071	May 13,14	May 12,15
Test software	ADT	ADT_Cond_V7.3.7	N/A	N/A	N/A

- NOTE:**
- 1. The calibration interval of the above test instruments is 12 months and the calibrations are traceable to CEPREI/CHINA, GRGT/CHINA and NIM/CHINA.
 - 2. The test was performed in shielding room 843.



3.1.3 TEST PROCEDURE

- a. The EUT was placed 0.4 meters from the conducting wall of the shielded room with EUT being connected to the power mains through a line impedance stabilization network (LISN). Other support units were connected to the power mains through another LISN. The two LISNs provide 50 Ohm/ 50uH of coupling impedance for the measuring instrument.
- b. Both lines of the power mains connected to the EUT were checked for maximum conducted interference.
- c. The frequency range from 150 kHz to 30 MHz was searched. Emission levels under (Limit – 20dB) were not recorded.

3.1.4 DEVIATION FROM TEST STANDARD

No deviation

3.1.5 TEST SETUP

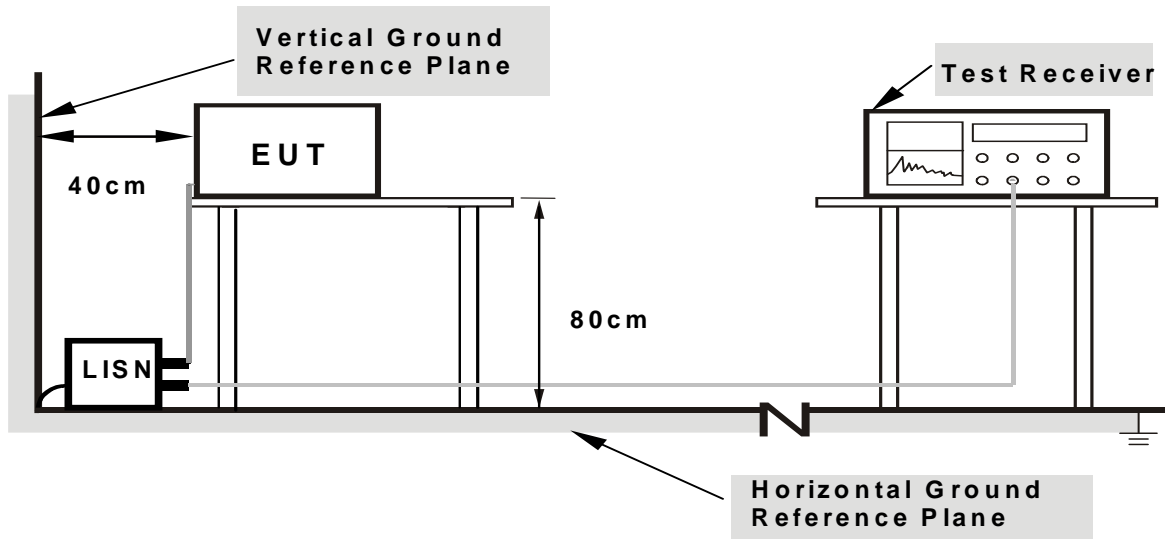

- Note:**
1. Support units were connected to second LISN.
 2. Both of LISNs (AMN) are 80cm from EUT and at least 80cm from other units and other metal planes support units.

3.1.6 EUT OPERATING CONDITIONS

- a. Turned on the power of all equipment.
- b. EUT was operated according to the type description in manufacturer's specifications or the User's Manual.



3.1.7 TEST RESULTS

TEST MODE	SOFAR 3000TL Grid Mode	6dB BANDWIDTH	9 kHz
TEST VOLTAGE	DC 360V	PHASE	Line (L)
ENVIRONMENTAL CONDITIONS	23 deg. C, 42% RH	TESTED BY: Heise	

No	Freq. [MHz]	Corr. Factor (dB)	Reading Value		Emission Level		Limit		Margin	
			[dB (uV)]		[dB (uV)]		[dB (uV)]		(dB)	
			Q.P.	AV.	Q.P.	AV.	Q.P.	AV.	Q.P.	AV.
1	0.16172	5.20	48.57	45.49	53.77	50.69	65.38	55.38	-11.60	-4.68
2	0.27891	9.16	40.76	37.52	49.92	46.68	60.85	50.85	-10.93	-4.17
3	0.31797	9.23	39.58	36.34	48.81	45.57	59.76	49.76	-10.95	-4.19
4	0.36094	9.32	39.63	36.39	48.95	45.71	58.71	48.71	-9.76	-3.00
5	0.43906	9.47	36.61	34.20	46.08	43.67	57.08	47.08	-11.00	-3.41
6	4.25000	10.01	32.52	25.58	42.53	35.59	56.00	46.00	-13.47	-10.41

REMARKS: The emission levels of other frequencies were very low against the limit.

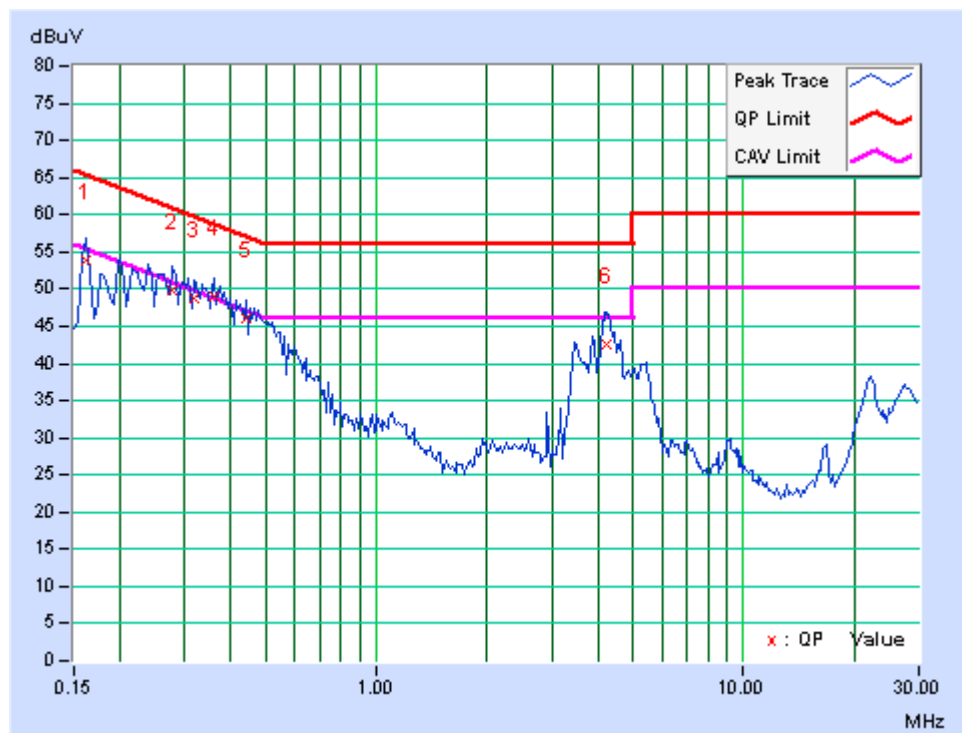



TEST MODE	SOFAR 3000TL	6dB BANDWIDTH	9 kHz
	Grid Mode		
TEST VOLTAGE	DC 360V	PHASE	Neutral (N)
ENVIRONMENTAL CONDITIONS	23 deg. C, 42% RH	TESTED BY: Heise	

No	Freq. [MHz]	Corr. Factor (dB)	Reading Value		Emission Level		Limit		Margin	
			[dB (uV)]		[dB (uV)]		[dB (uV)]		(dB)	
			Q.P.	AV.	Q.P.	AV.	Q.P.	AV.	Q.P.	AV.
1	0.15781	4.85	47.50	43.90	52.35	48.75	65.58	55.58	-13.22	-6.82
2	0.28281	9.19	39.88	36.67	49.07	45.86	60.73	50.73	-11.67	-4.88
3	0.37656	9.35	38.15	35.11	47.50	44.46	58.35	48.35	-10.85	-3.89
4	0.43906	9.46	36.24	33.89	45.70	43.35	57.08	47.08	-11.38	-3.73
5	0.48203	9.54	35.42	33.03	44.96	42.57	56.30	46.30	-11.35	-3.74
6	4.22266	10.05	33.58	25.62	43.63	35.67	56.00	46.00	-12.37	-10.33

REMARKS: The emission levels of other frequencies were very low against the limit.

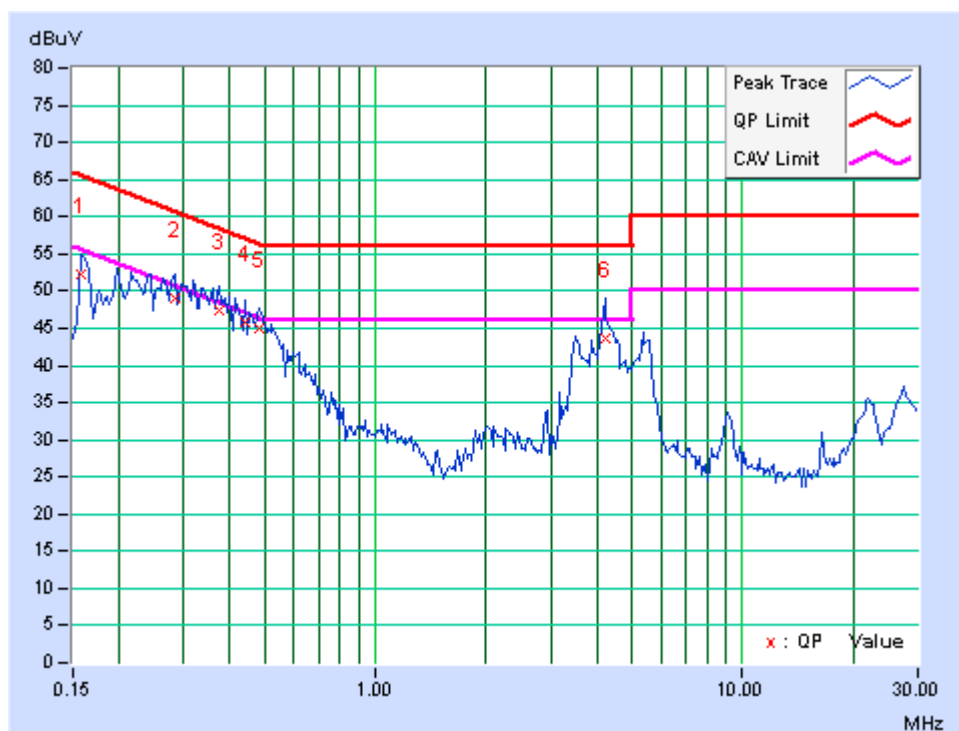



3.2 RADIATED EMISSION MEASUREMENT

3.2.1 LIMITS OF RADIATED EMISSION MEASUREMENT

TEST STANDARD: EN 61000-6-3

FOR FREQUENCY BELOW 1000 MHz

FREQUENCY (MHz)	Class A (at 10m)	Class B (at 10m)
	dBuV/m	dBuV/m
30 – 230	40	30
230 – 1000	47	37

FREQUENCY RANGE OF RADIATED MEASUREMENT

(For unintentional radiators)

Highest frequency generated or Upper frequency of measurement used in the device or on which the device operates or tunes (MHz)	Range (MHz)
Below 108	1000
108 – 500	2000
500 – 1000	5000
Above 1000	Up to 5 times of the highest frequency or 6 GHz, whichever is less

FOR FREQUENCY ABOVE 1000 MHz

FREQUENCY (GHz)	Class A (dBuV/m) (at 3m)		Class B (dBuV/m) (at 3m)	
	PEAK	AVERAGE	PEAK	AVERAGE
1 to 3	76	56	70	50
3 to 6	80	60	74	54

- NOTE:** (1) The lower limit shall apply at the transition frequencies.
(2) Emission level (dBuV/m) = 20 log Emission level (uV/m).
(3) All emanation from a class A/B digital device or system, including any network of conductors and apparatus connected thereto, shall not exceed the level of field strengths specified above.



3.2.2 TEST INSTRUMENTS

Frequency Range 30MHz-1GHz

Equipment	Manufacturer	Model No.	Serial No.	Last Cal.	Next Cal.
EMI Test Receiver	Rohde&Schwarz	ESCI	100962	Mar. 06,14	Mar. 05,15
Bilog Antenna	Teseq	CBL 6111D	27089	Jul. 27, 13	Jul. 26, 14
Trilog-Broadband Antenna	SCHWARZBECK	VULB 9168	9168-554	Dec. 03, 13	Dec. 02, 14
Trilog-Broadband Antenna	SCHWARZBECK	VULB 9168	9168-555	Dec. 03, 13	Dec. 02, 14
10m Semi-anechoic Chamber	CHANGLING	21.4m*12.1m*8.8m	NSEMC006	Jun. 11, 13	Jun. 10, 14
Amplifier (9kHz-1GHz)	SONOMA	310D	186955	Mar. 05,14	Mar. 04, 15
Test Software	ADT	ADT_Radiated_V7.6.15.9.2	N/A	N/A	N/A

Frequency Range Above1GHz

Equipment	Manufacturer	Model No.	Serial No.	Last Cal.	Next Cal.
Horn Antenna	ETS-Lindgren	3117	00062558	Oct. 18,12	Oct. 17,14
EMI Test Receiver	Rohde&Schwarz	ESCI	100962	Mar. 06,14	Mar. 05,15
Spectrum Analyzer	Rohde&Schwarz	FSV40	101003	Apr. 09,14	Apr. 08,15
Pre-Amplifier (100MHz-26.5GHz)	EMCI	EMC 012645	980077	Nov. 07,13	Nov. 06,14
Pre-Amplifier (18GHz-40GHz)	EMCI	EMC 184045	980102	Nov. 04,13	Nov. 03,14
Test Software	ADT	ADT_Radiated_V7.6.15.9.2	N/A	N/A	N/A

- NOTE:** 1. The calibration interval of the above test instruments is 12 months. And the calibrations are traceable to CEPREI/CHINA and NIM/CHINA.
2. The test was performed in Chamber 10m.



3.2.3 TEST PROCEDURE

<Frequency Range below 1GHz>

- a. The EUT was placed on the top of a rotating table 0.8 meters above the ground at a 10 meter chamber room. The table was rotated 360 degrees to determine the position of the highest radiation.
- b. The EUT was set 10 meters away from the interference-receiving antenna, which was mounted on the top of a variable-height antenna tower.
- c. The height of antenna is varied from one meter to four meters above the ground to determine the maximum value of the field strength. Both horizontal and vertical polarizations of the antenna are set to make the measurement.
- d. For each suspected emission, the EUT was arranged to its worst case and then the antenna was tuned to heights from 1 meter to 4 meters and the turn table was turned from 0 degrees to 360 degrees to find the maximum reading.
- e. The test-receiver system was set to quasi-peak detect function and specified bandwidth with maximum hold mode when the test frequency is below 1 GHz.

NOTE:

1. The resolution bandwidth of test receiver/spectrum analyzer is 120kHz for Quasi-peak detection (QP) at frequency below 1GHz.
2. Emission level(dBuV/m)=Raw Value(dBuV) + Correction Factor(dB/m)
3. Correction Factor(dB/m) = Antenna Factor (dB/m) + Cable Factor (dB)
4. Margin value = Emission level – Limit value.



<Frequency Range above 1GHz>

- a. The EUT was placed on the top of a rotating table 0.8 meters above the ground at a 10 meter Semi-anechoic chamber room. The table was rotated 360 degrees to determine the position of the highest radiation.
- b. The EUT was set 3 meters away from the interference-receiving antenna, which was mounted on the top of a variable-height antenna tower.
- c. The height of antenna can be varied from one meter-to four meters, the height of adjustment depends on the EUT height and the antenna 3dB beamwidth both, to detect the maximum value of the field strength. Both horizontal and vertical polarizations of the antenna are set to make the measurement.
- d. For each suspected emission, the EUT was arranged to its worst case and then the antenna was tuned to heights and the rotatable table was turned from 0 degrees to 360 degrees to find the maximum reading.
- e. The test receiver/spectrum was set to peak and average detect function and specified bandwidth with maximum hold mode when the test frequency is above 1 GHz.

NOTE:

1. The resolution bandwidth is 1MHz and video bandwidth of test receiver/spectrum analyzer is 3MHz for Peak detection at frequency above 1GHz. The resolution bandwidth of test receiver/spectrum analyzer is 1 MHz for Average detection (AV) at frequency above 1GHz.
2. For measurement of frequency above 1000 MHz, the EUT was set 3 meters away from the receiver antenna.

3.2.4 DEVIATION FROM TEST STANDARD

No deviation

3.2.5 TEST SETUP

<Frequency Range below 1GHz>

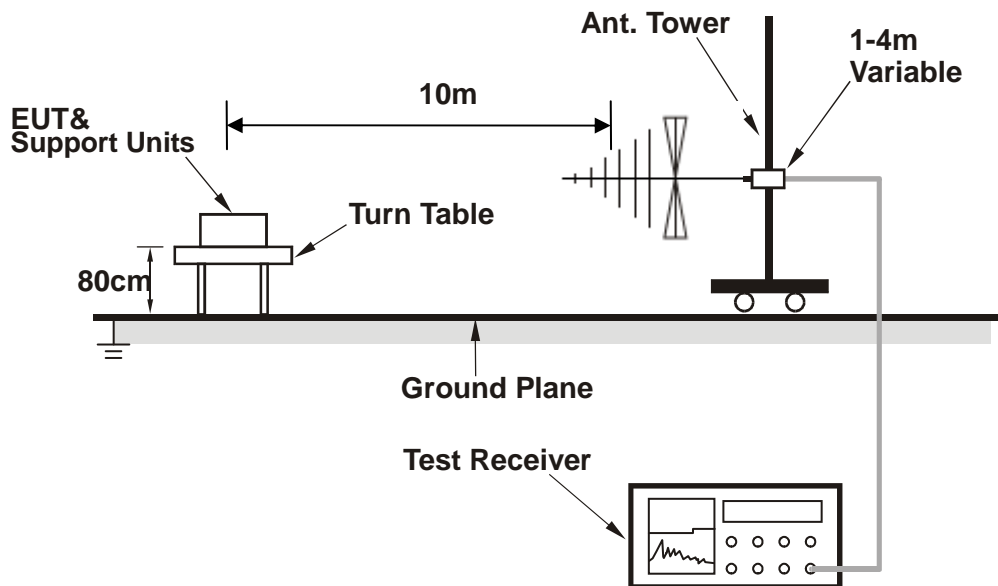

<Frequency Range above 1GHz>

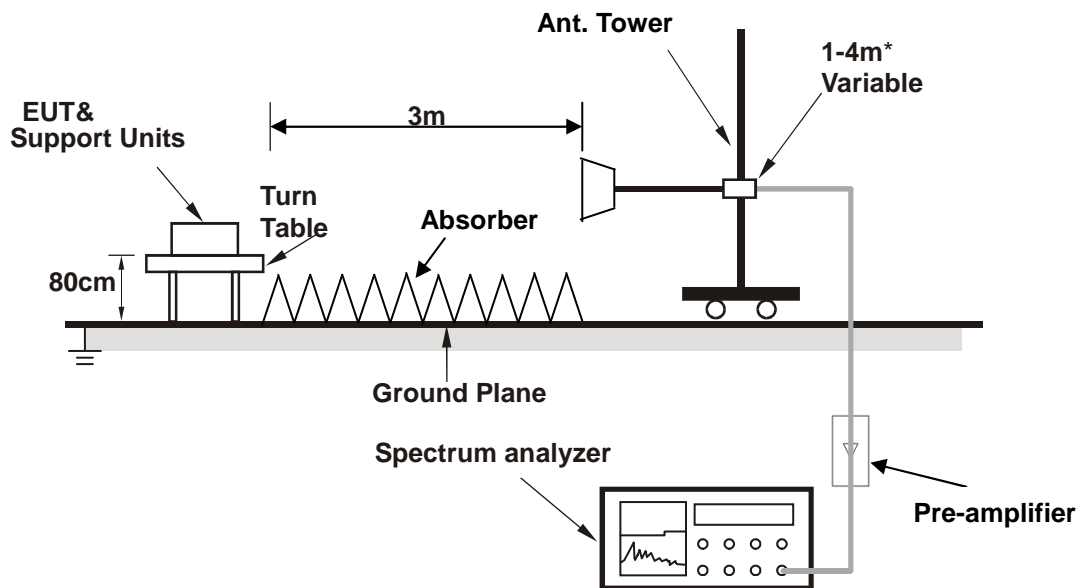

* : depends on the EUT height and the antenna 3dB beamwidth both, refer to section 7.3 of CISPR 16-2-3.

3.2.6 EUT OPERATING CONDITIONS

Same as item 3.1.6



3.2.7 TEST RESULTS

TEST MODE	SOFAR 3000TL Grid Mode	FREQUENCY RANGE	30-1000 MHz
TEST VOLTAGE	DC 360V	DETECTOR FUNCTION & BANDWIDTH	Quasi-Peak, 120kHz
ENVIRONMENTAL CONDITIONS	25 deg. C, 50% RH	TESTED BY: Robert	

ANTENNA POLARITY & TEST DISTANCE: HORIZONTAL AT 10 M								
No.	Freq. (MHz)	Correction Factor (dB/m)	Raw Value (dBuV)	Emission Level (dBuV/m)	Limit (dBuV/m)	Margin (dB)	Antenna Height (cm)	Table Angle (Degree)
1	43.58	14.96	-0.74	14.22	30.00	-15.78	143	12
2	92.08	10.26	9.47	19.73	30.00	-10.27	400	31
3	113.42	12.35	9.75	22.10	30.00	-7.90	400	313
4	130.88	13.26	11.50	24.76	30.00	-5.24	400	122
5	183.26	12.88	6.59	19.47	30.00	-10.53	219	132
6	247.28	14.09	5.71	19.80	37.00	-17.20	100	13

REMARKS: The emission levels of other frequencies were very low against the limit..

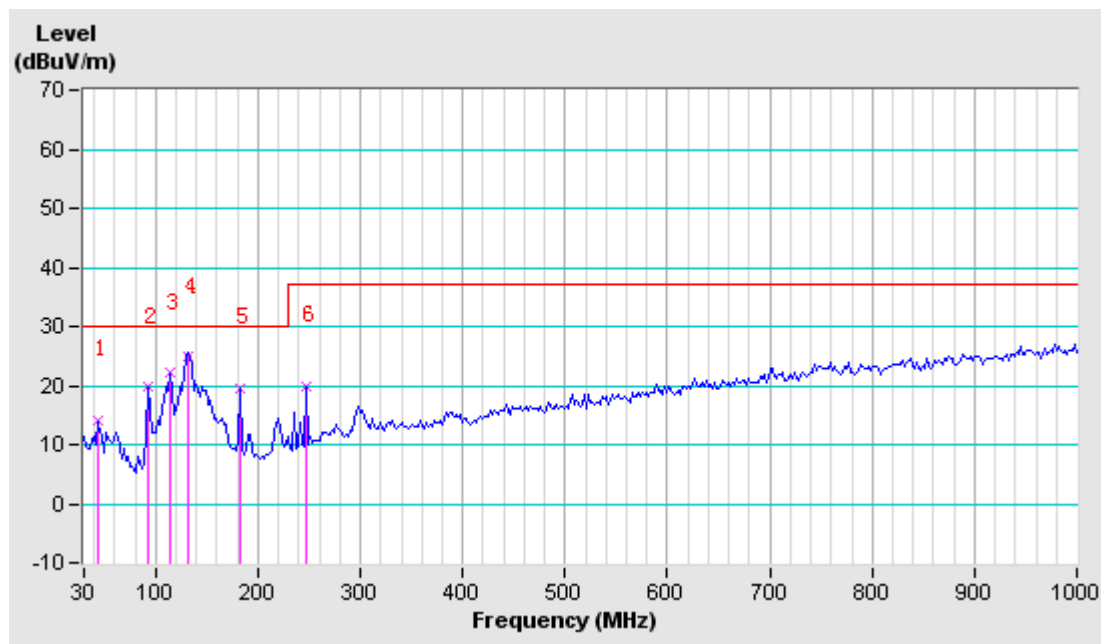



TEST MODE	SOFAR 3000TL Grid Mode	FREQUENCY RANGE	30-1000 MHz
TEST VOLTAGE	DC 360V	DETECTOR FUNCTION & BANDWIDTH	Quasi-Peak, 120kHz
ENVIRONMENTAL CONDITIONS	25 deg. C, 50% RH	TESTED BY: Robert	

ANTENNA POLARITY & TEST DISTANCE: VERTICAL AT 10 M								
No.	Freq. (MHz)	Correction Factor (dB/m)	Raw Value (dBuV)	Emission Level (dBuV/m)	Limit (dBuV/m)	Margin (dB)	Antenna Height (cm)	Table Angle (Degree)
1	43.58	14.96	9.04	24.00	30.00	-6.00	195	129
2	61.04	13.28	9.31	22.59	30.00	-7.41	165	104
3	94.00	10.50	12.90	23.40	30.00	-6.60	100	20
4	130.88	13.26	6.84	20.10	30.00	-9.90	100	20
5	191.02	12.37	12.55	24.92	30.00	-5.08	128	72
6	220.12	12.64	8.38	21.02	30.00	-8.98	231	160

REMARKS: The emission levels of other frequencies were very low against the limit.

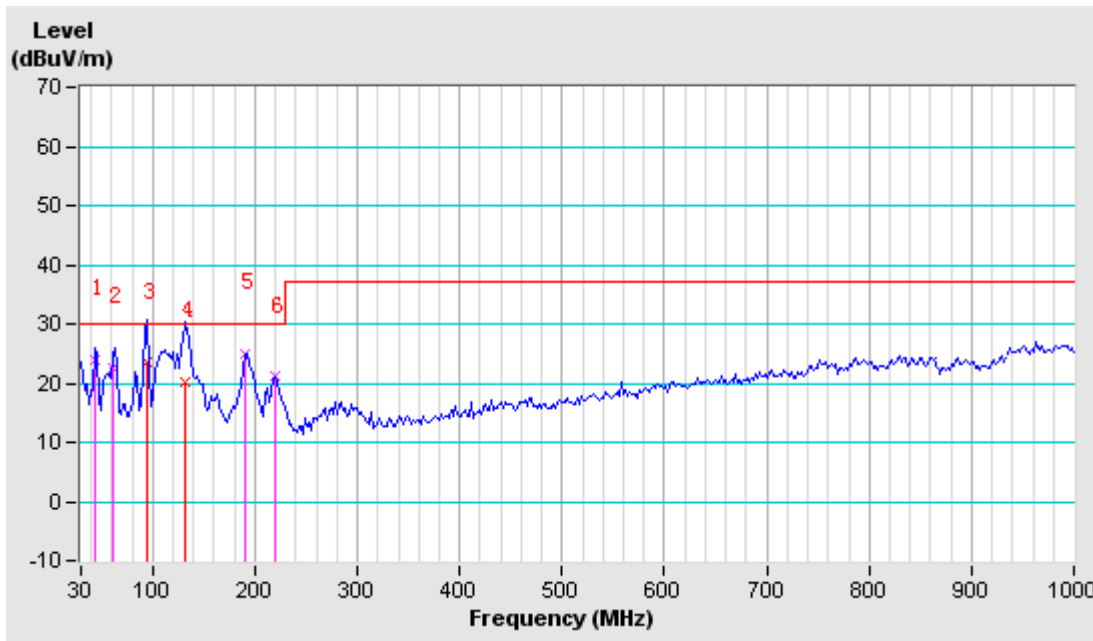



3.3 HARMONICS CURRENT MEASUREMENT (<16A)

3.3.1 LIMITS OF HARMONICS CURRENT MEASUREMENT

TEST STANDARD: EN 61000-3-2

Limits for Class A equipment		Limits for Class D equipment		
Harmonic Order n	Max. permissible harmonics current A	Harmonic Order n	Max. permissible harmonics current per watt mA/W	Max. permissible harmonics current A
Odd harmonics		Odd Harmonics only		
3	2.30	3	3.4	2.30
5	1.14	5	1.9	1.14
7	0.77	7	1.0	0.77
9	0.40	9	0.5	0.40
11	0.33	11	0.35	0.33
13	0.21	13	0.30	0.21
15<=n<=39	0.15x15/n	15<=n<=39	3.85/n	0.15x15/n
Even harmonics				
2	1.08			
4	0.43			
6	0.30			
8<=n<=40	0.23x8/n			

NOTE: 1. Class A and Class D are classified according to section 5 of EN 61000-3-2.

2. According to section 7 of EN 61000-3-2, the above limits for all equipment except for lighting equipment having an active power input > 75 W and no limits apply for equipment with an active power input up to and including 75 W.

◆ **Limits for Class B equipment:**

For class B equipment, the harmonics of the input current shall not exceed the maximum permissible values given for class A equipment multiplied by a factor of 1.5.

Limits for Class C equipment	
Harmonic Order n	Max. permissible harmonics current expressed as a percentage of the input current at the fundamental frequency %
2	2
3	30 · λ
5	10
7	7
9	5
11<=n<=39 (odd harmonics only)	3
λ is the circuit power factor	

NOTE: Discharge lighting equipment having an active TEST VOLTAGE smaller than or equal to 25W, the harmonic currents shall not exceed the power related limits of Class D.



3.3.2 TEST INSTRUMENTS

DESCRIPTION & MANUFACTURER	MANUFACTURER	MODEL NO.	SERIAL NO.	CALIBRATED DATE	CALIBRATED UNTIL
PRECISION POWER ANALYZER	YOKOGAWA	WT3000	91M210852	Mar. 12,14	Mar. 11,15
Test Software	YOKOGAWA	IEC61000	N/A	N/A	N/A
REFERENCE IMPEDANCE NETWORK	Voltech	EUR	3018	N/A	N/A

- NOTE:** 1. The test was performed in PV Room.
 2. The calibration interval of the above test instruments is 12 months and the calibrations are traceable to CEPREI/CHINA, GRGT/CHINA and NIM/CHINA.

3.3.3 TEST PROCEDURE

- a. The EUT was placed on the top of a wooden table 0.8 meters above the ground and operated to produce the maximum harmonic components under normal operating conditions for each successive harmonic component in turn.
- b. The classification of EUT is according to section 5 of EN 61000-3-2:2006 + A1:2009 + A2:2009.

The EUT is classified as follows:

Class A: Balanced three-phase equipment, Household appliances excluding equipment as Class D, Tools excluding portable tools, Dimmers for incandescent lamps, audio equipment, equipment not specified in one of the three other classes.

Class B: Portable tools. ; Arc welding equipment which is not professional equipment

Class C: Lighting equipment.

Class D: Equipment having a specified power less than or equal to 600 W of the following types: Personal computers and personal computer monitors and television receivers.

- c. The correspondent test program of test instrument to measure the current harmonics emanated from EUT is chosen. The measure time shall be not less than the time necessary for the EUT to be exercised.



3.3.4 DEVIATION FROM TEST STANDARD

No deviation

3.3.5 TEST SETUP

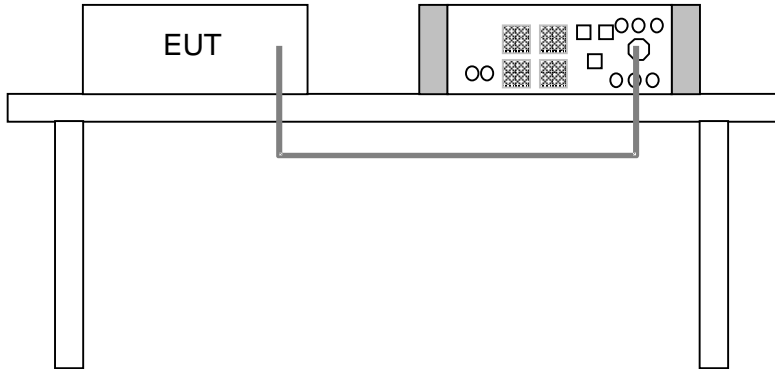

3.3.6 EUT OPERATING CONDITIONS

Same as item 3.1.6



3.3.7 TEST RESULTS

SOFAR 1100TL

***** appliances (Average)

Print Date : Mon May 26 14:15:38 2014
 MeasureDate : Mon May 26 14:15:34 2014
 Comment : Experimental model Pattern A

Regulation : IEC61000-3-2 Ed3.0 am2
 IEC61000-4-7 Ed2.0 A1
 Class : CLASS A
 MeasureTime : 150.00sec
 Model : YOKOGAWA WT3000
 Rating Voltage : 230.00 V
 Wiring : single-phase 2-wire
 Element : 1
 Range : 300V/30A
 Current(rms) : 4.2800 A
 Voltage(rms) : 230.42 V
 Frequency : 50.000 Hz
 Power Factor : 0.9957
 POHC Limit : 0.2514 A
 POHC Max : 0.0040 A
 THC : 0.0658 A

PASS

Set Fundamental I : -----
 Set Power Factor : -----
 Set P : -----
 Sigma W Max : 982.9105 W
 Sigma PF : 0.9957
 Distortion factor(V) : 0.05 %
 V THDS : 0.05 %
 V THDG : 0.05 %
 Distortion factor(A) : 1.53 %
 A THDS : 1.53 %
 A THDG : 1.54 %
 P THD : 0.00 %
 Power Limit : 75 W

Order	Measure[A]	Limit[A]	Margin[%]	Order	Measure[A]	Limit[A]	Margin[%]
1	4.2795			2	0.0095	1.0800	99.1
3	0.0632	2.3000	97.3	4	0.0045	0.4300	99.0
5	0.0096	1.1400	99.2	6	0.0031	0.3000	99.0
7	0.0061	0.7700	99.2	8	0.0022	0.2300	99.0
9	0.0036	0.4000	99.1	10	0.0023	0.1840	98.8
11	0.0021	0.3300	99.4	12	0.0023	0.1533	98.5
13	0.0019	0.2100	99.1	14	0.0018	0.1314	98.6
15	0.0015	0.1500	99.0	16	0.0016	0.1150	98.6
17	0.0014	0.1324	99.0	18	0.0018	0.1022	98.3
19	0.0015	0.1184	98.8	20	0.0016	0.0920	98.3
21	0.0017	0.1071	98.4	22	0.0013	0.0836	98.4
23	0.0014	0.0978	98.6	24	0.0012	0.0767	98.4
25	0.0015	0.0900	98.3	26	0.0014	0.0708	98.0
27	0.0012	0.0833	98.6	28	0.0011	0.0657	98.3
29	0.0012	0.0776	98.5	30	0.0010	0.0613	98.4
31	0.0010	0.0726	98.7	32	0.0011	0.0575	98.1
33	0.0011	0.0682	98.4	34	0.0013	0.0541	97.6
35	0.0011	0.0643	98.3	36	0.0012	0.0511	97.7
37	0.0009	0.0608	98.5	38	0.0012	0.0484	97.6
39	0.0009	0.0577	98.5	40	0.0015	0.0460	96.8

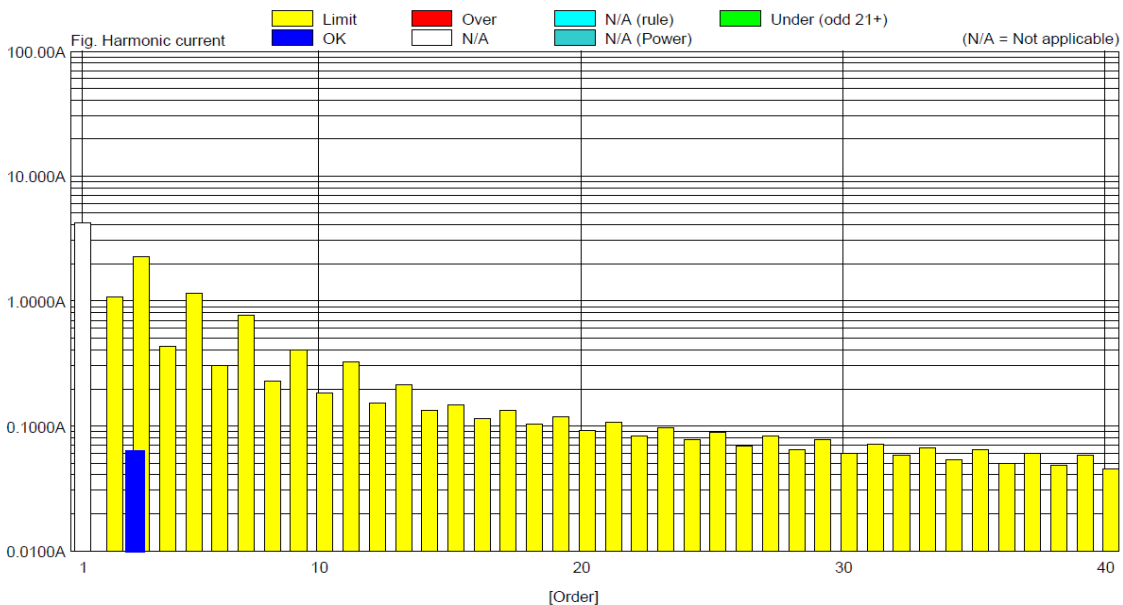



BUREAU VERITAS

Test Report No.: CE140508N005R1

***** appliances (Maximum)

Print Date : Mon May 26 14:15:38 2014
MeasureDate : Mon May 26 14:15:34 2014
Comment : Experimental model Pattern A

Regulation : IEC61000-3-2 Ed3.0 am2
CLASS A
MeasureTime : 150.00sec
Model : YOKOGAWA WT3000
Rating Voltage : 230.00 V
Wiring : single-phase 2-wire
Element : 1
Range : 300V/30A
Current(rms) : 4.2840 A
Voltage(rms) : 230.42 V
Frequency : 50.004 Hz
Power Factor : 0.9957
Beyond Limit Time : 15.0000 s
Beyond Total Time : 0.0000 s
THC : 0.0661 A

PASS

Set Fundamental I : -----
Set Power Factor : -----
Set P : -----
Sigma W Max : 982.9105 W
Sigma PF : 0.9957
Distortion factor(V) : 0.05 %
V THDS : 0.05 %
V THDG : 0.05 %
Distortion factor(A) : 1.55 %
A THDS : 1.55 %
A THDG : 1.56 %
P THD : 0.00 %
Power Limit : 75 W

Table with 8 columns: Order, Measure[A], Limit[A], Margin[%], Order, Measure[A], Limit[A], Margin[%]. It lists 40 harmonic orders with their respective measured values, limits, and margins.

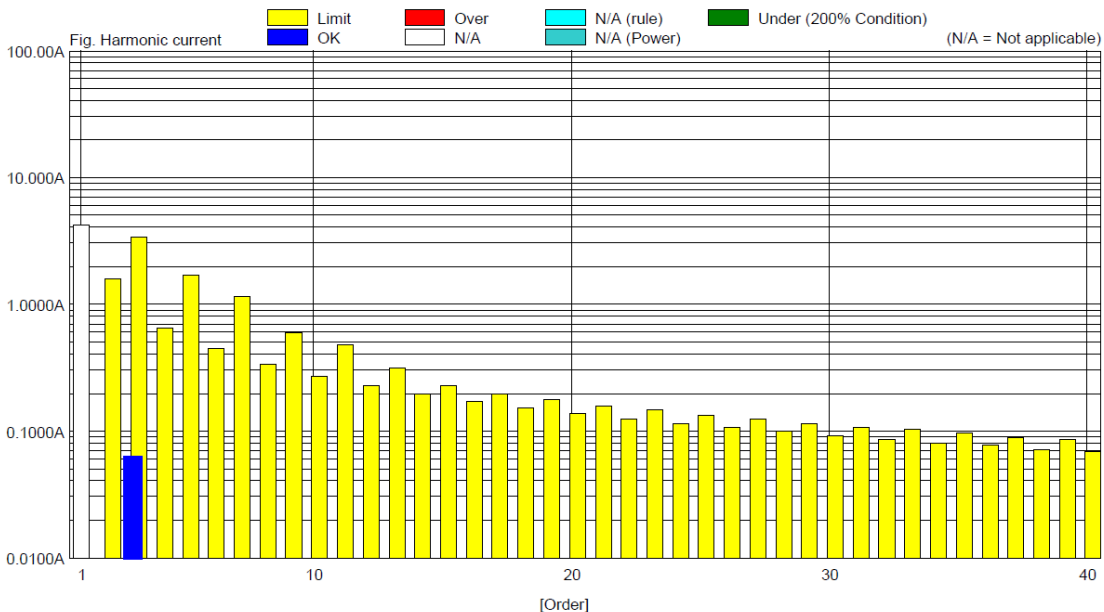

Bureau Veritas Shenzhen Co., Ltd.
Dongguan Branch

No. 34, Chenwulu Section, Guantai Rd., Houjie
Town, Dongguan City,
Guangdong 523942, China

Tel: +86 769 8593 5656
Fax: +86 769 8593 1080
Email: customerservice.dg@cn.bureauveritas.com



SOFAR 3000TL

***** appliances (Average)

Print Date : Wed Jun 11 11:32:38 2014
MeasureDate : Wed Jun 11 11:31:38 2014
Comment : Experimental model Pattern A

Regulation : IEC61000-3-2 Ed3.0 am2
Class : CLASS A
MeasureTime : 150.00sec
Model : YOKOGAWA WT3000
Rating Voltage : 230.00 V
Wiring : single-phase 2-wire
Element : 2
Range : 300V/30A
Current(rms) : 12.1893 A
Voltage(rms) : 229.99 V
Frequency : 49.999 Hz
Power Factor : 0.9998
POHC Limit : 0.2514 A
POHC Max : 0.0365 A
THC : 0.1683 A

PASS

Set Fundamental I : -----
Set Power Factor : -----
Set P : -----
Sigma W Max : 2804.014 W
Sigma PF : 0.9998
Distortion factor(V) : 0.04 %
V THDS : 0.04 %
V THDG : 0.04 %
Distortion factor(A) : 1.38 %
A THDS : 1.38 %
A THDG : 1.38 %
P THD : 0.00 %
Power Limit : 75 W

Table with 8 columns: Order, Measure[A], Limit[A], Margin[%], Order, Measure[A], Limit[A], Margin[%]. It lists harmonic data for orders 1 through 40.

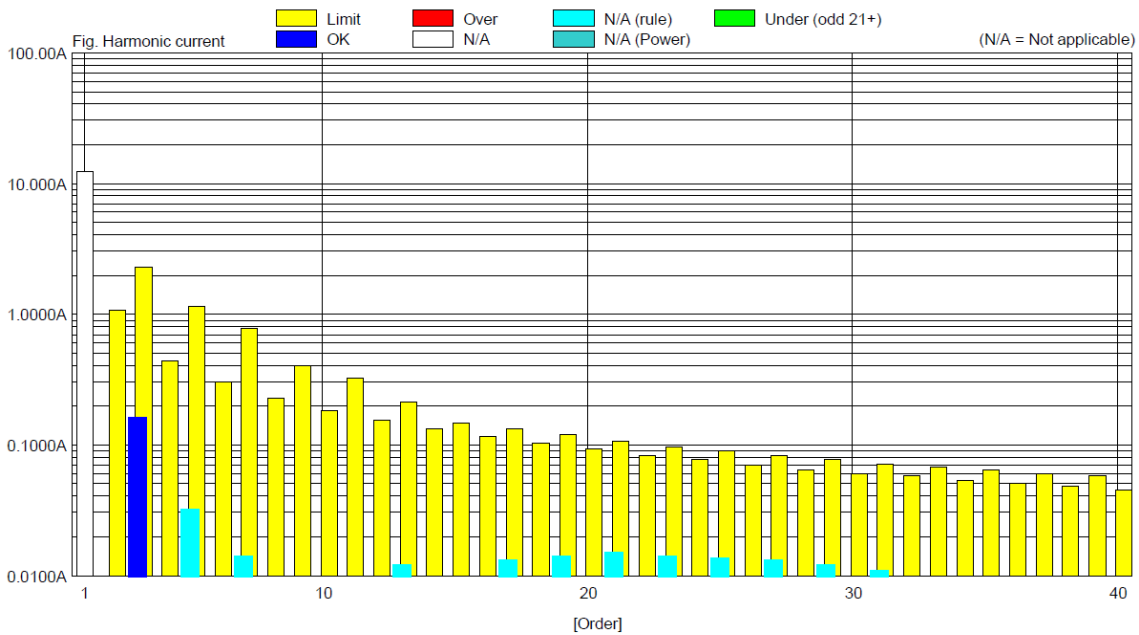



BUREAU VERITAS

Test Report No.: CE140508N005R1

***** appliances (Maximum)

Print Date : Wed Jun 11 11:32:39 2014
MeasureDate : Wed Jun 11 11:31:38 2014
Comment : Experimental model Pattern A

Regulation : IEC61000-3-2 Ed3.0 am2
Class : CLASS A
MeasureTime : 150.00sec
Model : YOKOGAWA WT3000
Rating Voltage : 230.00 V
Wiring : single-phase 2-wire
Element : 2
Range : 300V/30A
Current(rms) : 12.1941 A
Voltage(rms) : 229.99 V
Frequency : 50.018 Hz
Power Factor : 0.9998
Beyond Limit Time : 15.0002 s
Beyond Total Time : 0.0000 s
THC : 0.1694 A

PASS

Set Fundamental I : -----
Set Power Factor : -----
Set P : -----
Sigma W Max : 2804.014 W
Sigma PF : 0.9998
Distortion factor(V) : 0.04 %
V THDS : 0.04 %
V THDG : 0.04 %
Distortion factor(A) : 1.40 %
A THDS : 1.40 %
A THDG : 1.40 %
P THD : 0.00 %
Power Limit : 75 W

Table with 8 columns: Order, Measure[A], Limit[A], Margin[%], Order, Measure[A], Limit[A], Margin[%]. It lists 40 harmonic orders with their respective measured values, limits, and margins.

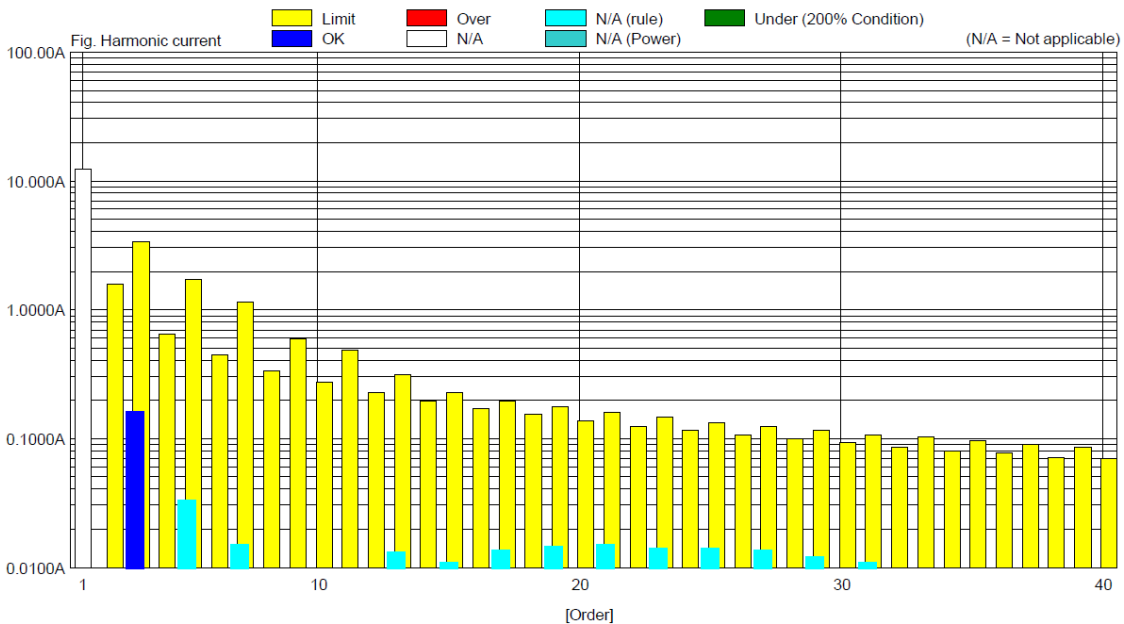

Bureau Veritas Shenzhen Co., Ltd.
Dongguan Branch

No. 34, Chenwulu Section, Guantai Rd., Houjie
Town, Dongguan City,
Guangdong 523942, China

Tel: +86 769 8593 5656
Fax: +86 769 8593 1080
Email: customerservice.dg@cn.bureauveritas.com



3.4 VOLTAGE FLUCTUATION AND FLICKS MEASUREMENT

3.4.1 LIMITS OF VOLTAGE FLUCTUATION AND FLICKS MEASUREMENT

TEST STANDARD: EN 61000-3-3

TEST ITEM	LIMIT	NOTE
P_{st}	1.0	P_{st} means short-term flicker indicator.
P_{lt}	0.65	P_{lt} means long-term flicker indicator.
$T_{d(t)}$ (ms)	500	$T_{d(t)}$ means maximum time that $d(t)$ exceeds 3.3%.
d_{max} (%)	4	d_{max} means maximum relative voltage change.
dc (%)	3.3	dc means relative steady-state voltage change

3.4.2 TEST INSTRUMENTS

DESCRIPTION & MANUFACTURER	MANUFACTURER	MODEL NO.	SERIAL NO.	CALIBRATED DATE	CALIBRATED UNTIL
PRECISION POWER ANALYZER	YOKOGAWA	WT3000	91M210852	Mar. 12,14	Mar. 11,15
Test Software	YOKOGAWA	IEC61000	N/A	N/A	N/A
REFERENCE IMPEDANCE NETWORK	Voltech	EUR	3018	N/A	N/A

NOTE: 1. The test was performed in PV Room.

2. The calibration interval of the above test instruments is 12 months and the calibrations are traceable to CEPREI/CHINA, GRGT/CHINA and NIM/CHINA.

3.4.3 TEST PROCEDURE

- a. The EUT was placed on the top of a wooden table 0.8 meters above the ground and operated to produce the most unfavorable sequence of voltage changes under Normal Operating conditions.
- b. During the flick measurement, the measure time shall include that part of whole operation cycle in which the EUT produce the most unfavorable sequence of voltage changes. The observation period for short-term flicker indicator is 120 minutes



3.4.4 DEVIATION FROM TEST STANDARD

No deviation

3.4.5 TEST SETUP

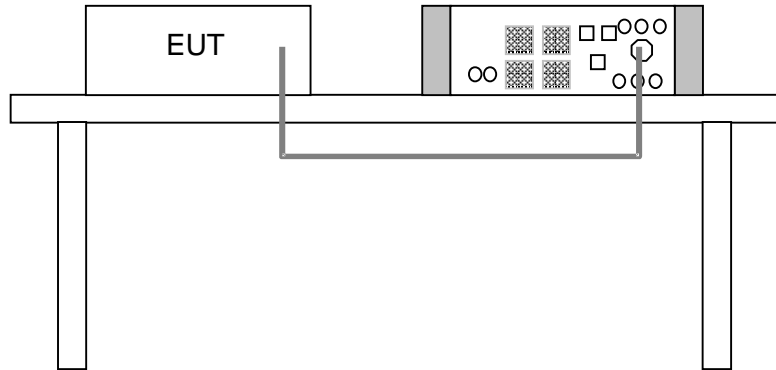

3.4.6 EUT OPERATING CONDITIONS

Same as item 3.1.6.



3.4.7 TEST RESULTS

SOFAR 1100TL

PV Inverter

Print Date : Mon May 26 16:26:18 2014
MeasureDate : Mon May 26 16:25:54 2014
Comment : Experimental model Pattern A

Regulation : IEC61000-3-3 Ed2.0
IEC61000-4-15 Ed1.1
Interval : 10Min0Sec
Model : YOKOGAWA WT3000
Wiring : single-phase 2wire
Voltage Range : 300.00V
Voltage U1 : 231.61V
Set Frequency : 50Hz
Frequency U1 : 50.000Hz
Element : 1
dmin : 0.10%

PASS(Under dmin)

Element1 : Pass(Under dmin)
dc (3.30%) : Pass
dmax (4.00%) : Pass
d(t) (500ms) : Pass
Pst (1.00) : Pass
Plt (0.65) : Pass

No.	dc[%]	dmax[%]	d(t)[ms]	Pst
1	0.00	0.00	0.00	0.07
2	0.00	0.00	0.00	0.07
3	0.00	0.00	0.00	0.07
4	0.00	0.00	0.00	0.07
5	0.00	0.00	0.00	0.07
6	0.00	0.00	0.00	0.07
7	0.00	0.00	0.00	0.07
8	0.00	0.00	0.00	0.07
9	0.00	0.00	0.00	0.07
10	0.00	0.00	0.00	0.07
11	0.00	0.00	0.00	0.07
12	0.00	0.00	0.00	0.07

Plt
0.07



SOFAR 3000TL

PV Inverter

Print Date : Fri Jun 13 11:17:38 2014
MeasureDate : Fri Jun 13 11:17:28 2014
Comment : Experimental model Pattern A

Regulation : IEC61000-3-3 Ed2.0
IEC61000-4-15 Ed1.1
Interval : 10Min0Sec
Model : YOKOGAWA WT3000
Wiring : single-phase 2wire
Voltage Range : 300.00V
Voltage U1 : 234.15V
Set Frequency : 50Hz
Frequency U1 : 50.000Hz
Element : 1
dmin : 0.10%

PASS(Under dmin)

Element1 : Pass(Under dmin)
dc (3.30%) : Pass
dmax (4.00%) : Pass
d(t) (500ms) : Pass
Pst (1.00) : Pass
Plt (0.65) : Pass

No.	dc[%]	dmax[%]	d(t)[ms]	Pst
1	0.00	0.00	0.00	0.07
2	0.00	0.00	0.00	0.07
3	0.00	0.00	0.00	0.07
4	0.00	0.00	0.00	0.07
5	0.00	0.00	0.00	0.07
6	0.00	0.00	0.00	0.07
7	0.00	0.00	0.00	0.07
8	0.00	0.00	0.00	0.07
9	0.00	0.00	0.00	0.07
10	0.00	0.00	0.00	0.07
11	0.00	0.00	0.00	0.07
12	0.00	0.00	0.00	0.07
				Plt
				0.07



4.1.2 PERFORMANCE CRITERIA

According to Clause 4 of EN 61000-6-2:2005 standard, the following describes the general performance criteria.

CRITERION A	The apparatus shall continue to operate as intended during and after the test. No degradation of performance or loss of function is allowed below a performance level specified by the manufacturer, when the apparatus is used as intended. The performance level may be replaced by a permissible loss of performance. If the minimum performance level or the permissible performance loss is not specified by the manufacturer, either of these may be derived from the product description and documentation and what the user may reasonably expect from the apparatus if used as intended.
CRITERION B	The apparatus shall continue to operate as intended after the test. No degradation of performance or loss of function is allowed below a performance level specified by the manufacturer, when the apparatus is used as intended. The performance level may be replaced by a permissible loss of performance. During the test, degradation of performance is however allowed. No change of operating state or stored data is allowed. If the minimum performance level or the permissible performance loss is not specified by the manufacturer, either of these may be derived from the product description and documentation and what the user may reasonably expect from the apparatus if used as intended.
CRITERION C	Temporary loss of function is allowed, provided the function is self-recoverable or can be restored by the operation of the controls.

4.1.3 EUT OPERATING CONDITION

Same as item 3.1.6



4.2 ELECTROSTATIC DISCHARGE IMMUNITY TEST (ESD)

4.2.1 TEST SPECIFICATION

Basic Standard:	IEC 61000-4-2
Discharge Impedance:	330 ohm / 150 pF
Discharge Voltage:	Air Discharge: 8 kV (Direct) Contact Discharge: 4 kV (Indirect)
Polarity:	Positive & Negative
Number of Discharge:	20 times at each test point
Discharge Mode:	Single Discharge
Discharge Period:	1 second

4.2.2 TEST INSTRUMENTS

Equipment	Manufacturer	Model No.	Serial No.	Last Cal.	Next Cal.
ESD Generator	TESEQ	NSG 437	279	Oct. 12, 13	Oct. 11, 14
Test Software	TESEQ	V03.03	N/A	N/A	N/A
ESD Generator	EM TEST	Dito	V1211112265	Jun. 19,14	Jun. 18,15
Test Software	EM TEST	V 2.31	N/A	N/A	N/A

- NOTE:**
1. The test was performed in ESD Room.
 2. The calibration interval of the above test instruments is 12 months and the calibrations are traceable to CEPREI/CHINA, GRGT/CHINA and NIM/CHINA.



4.2.3 TEST PROCEDURE

The basic test procedure was in accordance with IEC 61000-4-2:

- a. Electrostatic discharges were applied only to those points and surfaces of the EUT that are accessible to users during normal operation.
- b. The test was performed with at least ten single discharges on the pre-selected points in the most sensitive polarity.
- c. The time interval between two successive single discharges was at least 1 second.
- d. The ESD generator was held perpendicularly to the surface to which the discharge was applied and the return cable was at least 0.2 meters from the EUT.
- e. Contact discharges were applied to the non-insulating coating, with the pointed tip of the generator penetrating the coating and contacting the conducting substrate.
- f. Air discharges were applied with the round discharge tip of the discharge electrode approaching the EUT as fast as possible (without causing mechanical damage) to touch the EUT. After each discharge, the ESD generator was removed from the EUT and re-triggered for a new single discharge. The test was repeated until all discharges were complete.
- g. At least ten single discharges (in the most sensitive polarity) were applied to the **Horizontal Coupling Plane** at points on each side of the EUT. The ESD generator was positioned horizontal at a distance of 0.1 meters from the EUT with the discharge electrode touching the **HCP**.
- h. At least ten single discharges (in the most sensitive polarity) were applied to the center of one vertical edge of the **Vertical Coupling Plane** in sufficiently different positions that the four faces of the EUT were completely illuminated. The **VCP** (dimensions 0.5m x 0.5m) was placed vertically to and 0.1 meters from the EUT.

4.2.4 DEVIATION FROM TEST STANDARD

No Deviation



4.2.5 TEST SETUP

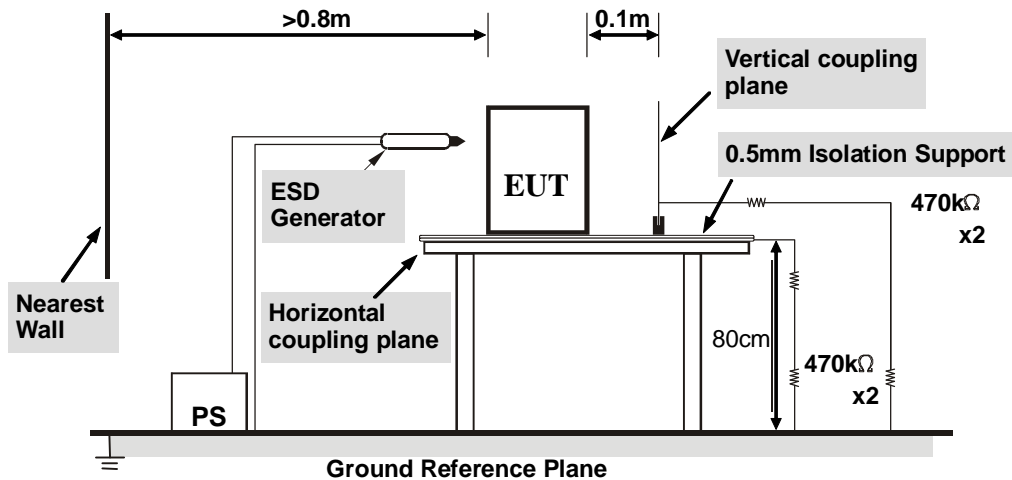

NOTE:

TABLE-TOP EQUIPMENT

The configuration consisted of a wooden table 0.8 meters high standing on the **Ground Reference Plane**. The **GRP** consisted of a sheet of aluminum at least 0.25mm thick, and 2.5 meters square connected to the protective grounding system. A **Horizontal Coupling Plane** (1.6m x 0.8m) was placed on the table and attached to the **GRP** by means of a cable with 940kΩ total impedance. The equipment under test, was installed in a representative system as described in section 7 of IEC 61000-4-2, and its cables were placed on the **HCP** and isolated by an insulating support of 0.5mm thickness. A distance of 1-meter minimum was provided between the EUT and the walls of the laboratory and any other metallic structure.

FLOOR-STANDING EQUIPMENT

The equipment under test was installed in a representative system as described in section 7 of IEC 61000-4-2, and its cables were isolated from the Ground Reference Plane by an insulating support of 0.1-meter thickness. The GRP consisted of a sheet of aluminum that is at least 0.25mm thick, and 2.5 meters square connected to the protective grounding system and extended at least 0.5 meters from the EUT on all sides.



4.2.6 TEST RESULTS

TEST MODE	See item 2.2	TEST VOLTAGE	DC 300V
ENVIRONMENTAL CONDITIONS	21.2deg. C, 51% RH 101.3kPa	TESTED BY: Heise	

Direct Discharge Application				
Test Level (kV)	Polarity	Test Point	Test Result of Contact Discharge	Test Result of Air Discharge
4	+/-	All Metal Part	A	N/A
8	+/-	All Non-metal Part	N/A	A

Indirect Discharge Application				
Discharge Level (kV)	Polarity	Test Point	Test Result of HCP	Test Result of VCP
4	+/-	HCP&VCP	A	A

NOTE: A: There was no change compared with initial operation during the test.



4.3 RADIATED, RADIO-FREQUENCY, ELECTROMAGNETIC FIELD IMMUNITY TEST (RS)

4.3.1 TEST SPECIFICATION

Basic Standard:	IEC 61000-4-3
Frequency Range:	80-1000MHz, 1400-2000MHz, 2000-2700MHz
Field Strength:	10V/m, 3V/m, 1V/m
Modulation:	1kHz Sine Wave, 80%, AM Modulation
Frequency Step:	1 % of fundamental
Polarity of Antenna:	Horizontal and Vertical
Antenna Height:	1.5m
Dwell Time:	at least 3 seconds

4.3.2 TEST INSTRUMENTS

Equipment	Manufacturer	Model No.	Serial No.	Last Cal.	Next Cal.
Signal Generator	Agilent	N5181A	MY50142530	Nov. 01,13	Oct. 31,14
Antenna Log-Periodic	CORAD	ATR80M6G	0337307	N/A	N/A
Antenna Log-Periodic	CORAD	ATS700M11G	0336821	N/A	N/A
Switch Controller	CORAD	SC1000	0337343	N/A	N/A
RF Power Meter	ESE	4242	13984	Nov. 04,13	Nov. 03,14
Power Sensor	ESE	51011EMC	35716	Nov. 04,13	Nov. 03,14
Power Sensor	ESE	51011EMC	35715	Nov. 04,13	Nov. 03,14
E-Field probe	Narda	NBM-520	2403/01B	May 07,14	May 06,15
Power Amplifier	TESEQ	CBA 1G-150	T44029	N/A	N/A
Power Amplifier	TESEQ	CBA 3G-100	T44030	N/A	N/A
Power Amplifier	TESEQ	CBA 6G-050	1041204	N/A	N/A
Dual Directional Coupler	TESEQ	C5982	95208	Dec. 23,13	Dec. 22,14
Dual Directional Coupler	TESEQ	C6187	95175	Dec. 23,13	Dec. 22,14
Dual Directional Coupler	TESEQ	CPH-274F	M251304-01	Dec. 23,13	Dec. 22,14
Test Software	ADT	BVADT_RS_V7.6 .4-DG	N/A	N/A	N/A

- NOTE:** 1. The test was performed in RS chamber.
2. The calibration interval of the above test instruments is 12 months and the calibrations are traceable to CEPREI/CHINA, GRGT/CHINA and NIM/CHINA.



4.3.3 TEST PROCEDURE

The test procedure was in accordance with IEC 61000-4-3

- a. The testing was performed in a fully-anechoic chamber.
- b. The frequency range is swept from 80 MHz to 1000 MHz, 1400MHz to 2000MHz, 2000MHz to 2700MHz with the signal 80% amplitude modulated with a 1kHz sine wave.
- c. The dwell time at each frequency shall not be less than the time necessary for the EUT to be exercised and to respond, but shall in no case be less than 0,5s.
- d. The field strength levels were 10V/m, 3V/m, 1V/m.
- e. The test was performed with the EUT exposed to both vertically and horizontally polarized fields on each of the four sides.

4.3.4 DEVIATION FROM TEST STANDARD

No Deviation



4.3.5 TEST SETUP

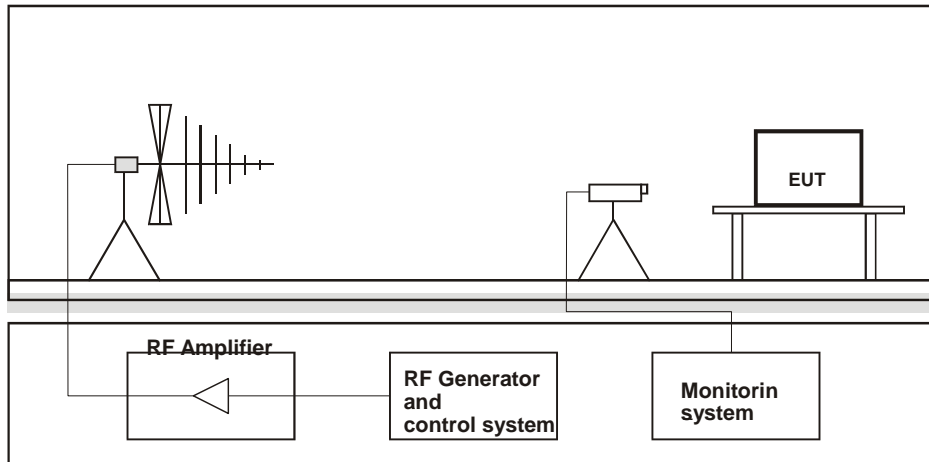

NOTE:

TABLETOP EQUIPMENT

The EUT installed in a representative system as described in section 7 of IEC 61000-4-3 was placed on a non-conductive table 0.8 meters in height. The system under test was connected to the power and signal wire according to relevant installation instructions.

FLOOR STANDING EQUIPMENT

The EUT installed in a representative system as described in section 7 of IEC 61000-4-3 was placed on a non-conductive wood support 0.1 meters in height. The system under test was connected to the power and signal wire according to relevant installation instructions.



4.3.6 TEST RESULTS

TEST MODE	See item 2.2	TEST VOLTAGE	DC 300V
ENVIRONMENTAL CONDITIONS	21.6deg. C, 57.5% RH	TESTED BY: Heise	

Field Strength (V/m)	Test Frequency Note#1 (MHz)	Polarization of antenna (Horizontal / Vertical)	Test Distance (m)	Test Result	Remark
10	80 - 1000	H&V	3	A	N/A
3	1400 - 2000	H&V	3	A	N/A
1	2000 - 2700	H&V	3	A	N/A

Note #1:

Tested Israel SII Frequencies 89,100,107,144,163,196,244,315,434,460,600,825,845,880 MHz

NOTE: A: There was no change compared with initial operation during the test.



4.4 ELECTRICAL FAST TRANSIENT/BURST IMMUNITY TEST (EFT)

4.4.1 TEST SPECIFICATION

Basic Standard:	IEC 61000-4-4
Test Voltage:	Power Line: 2kV
Polarity:	Positive & Negative
Impulse Frequency:	5 kHz
Impulse Waveshape :	5/50 ns
Burst Duration:	15 ms
Burst Period:	300 ms
Test Duration:	1 min.

4.4.2 TEST INSTRUMENTS

Equipment	Manufacturer	Model No.	Serial No.	Last Cal.	Next Cal.
EFT Tester	HAEFELY	PEFT4010	150546	May 17,14	May 16,15
EFT Coupling Clamp	HAEFELY	IP4A	150407	May 17,14	May 16,15
Test Software	HAEFELY	SWPE4010 1.22	N/A	N/A	N/A

- NOTE:** 1. The test was performed in EMS Room 1.
 2. The calibration interval of the above test instruments is 12 months and the calibrations are traceable to CEPREI/CHINA, GRGT/CHINA and NIM/CHINA.

4.4.3 TEST PROCEDURE

- Both positive and negative polarity discharges were applied.
- The length of the “hot wire” from the coaxial output of the EFT generator to the terminals on the EUT should not exceed 0.5 meter ± 0.05 meter.
- The duration time of each test sequential was 1 minute.
- The transient/burst waveform was in accordance with IEC 61000-4-4, 5/50ns.

4.4.4 DEVIATION FROM TEST STANDARD

No deviation.



4.4.5 TEST SETUP

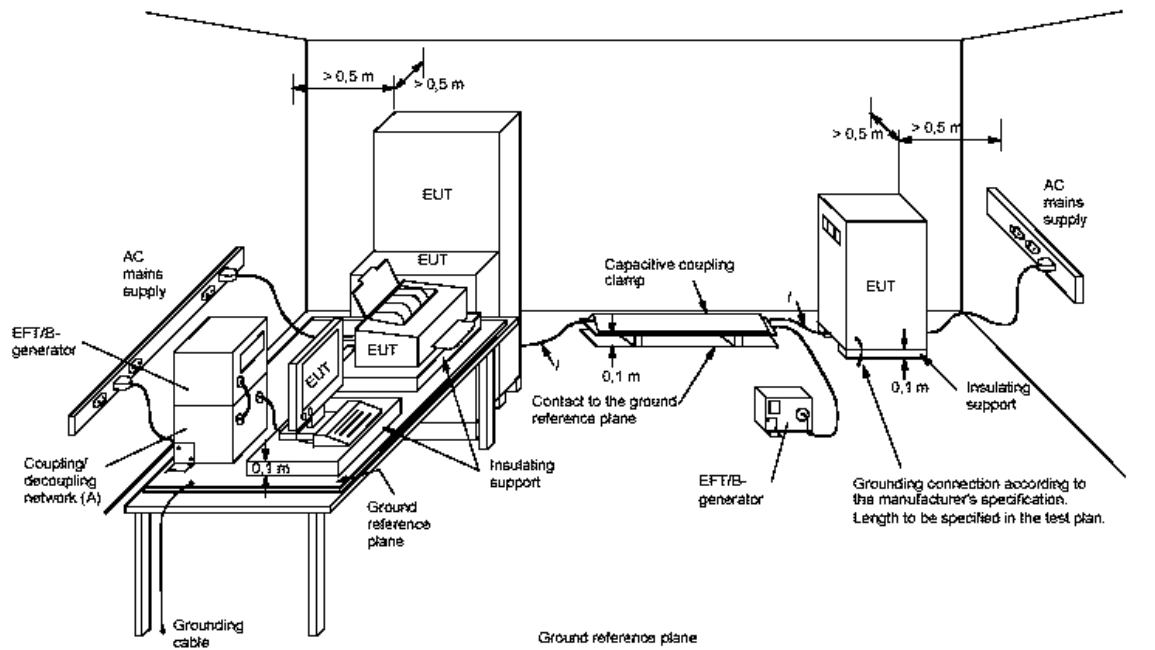

NOTE:

TABLETOP EQUIPMENT

The configuration consisted of a wooden table standing on the Ground Reference Plane and should be located 0.1m +/- 0.01m above the Ground Reference Plane. The GRP consisted of a sheet of aluminum (at least 0.25mm thick and 2.5m square) connected to the protective grounding system. A minimum distance of 0.5m was provided between the EUT and the walls of the laboratory or any other metallic structure.

FLOOR STANDING EQUIPMENT

The EUT installed in a representative system as described in section 7 of IEC 61000-4-4 and its cables, were isolated from the Ground Reference Plane by an insulating support that is 0.1-meter thick. The GRP consisted of a sheet of aluminum (at least 0.25mm thick and 2.5m square) connected to the protective grounding system.



4.4.6 TEST RESULTS

TEST MODE	See item 2.2	TEST VOLTAGE	DC 300V
ENVIRONMENTAL CONDITIONS	21.5 deg. C, 58.2% RH	TESTED BY: Heise	

Pulse Voltage	2 kV		kV		kV		kV	
Pulse Polarity	+	-	+	-	+	-	+	-
L	A	A	/	/	/	/	/	/
N	A	A	/	/	/	/	/	/
PE	A	A	/	/	/	/	/	/
L+N	A	A	/	/	/	/	/	/
L+PE	A	A	/	/	/	/	/	/
N+PE	A	A	/	/	/	/	/	/
L+N+PE	A	A	/	/	/	/	/	/
DC Line	A	A	/	/	/	/	/	/

NOTE: A: There was no change compared with initial operation during the test.



4.5 SURGE IMMUNITY TEST

4.5.1 TEST SPECIFICATION

Basic Standard:	IEC 61000-4-5
Wave-Shape:	Combination Wave 1.2/50 us Open Circuit Voltage 8 /20 us Short Circuit Current
Test Voltage:	AC Power Line: Line to Line:1kV Line to PE:2kV Signal Line: 1kV DC Power Line: Line to Line:0.5kV Line to PE:0.5kV
Surge Input/Output:	L-N&L-PE&N-PE, RJ 45 Line
Generator Source	2 ohm between networks
Impedance:	12 ohm between network and ground
Polarity:	Positive/Negative
Phase Angle:	0° /90°/180°/270°
Pulse Repetition Rate:	1 time / 60 sec.
Number of Tests:	5 positive and 5 negative at selected points

4.5.2 TEST INSTRUMENTS

Equipment	Manufacturer	Model No.	Serial No.	Last Cal.	Next Cal.
Combination wave Module	TESEQ AG	CDN 3061	1361	Feb. 17,14	Feb. 16,15
Telecom Surge Module	TESEQ AG	NSG 3060 Mainframe	1404	Feb. 17,14	Feb. 16,15
CDN	TESEQ	CDN HSS-2	34275	Nov.06, 13	Nov.05, 14
CDN	TESEQ	CDN 118	30741	Nov.06, 13	Nov.05, 14
Test Software	TESEQ	CDM 3061_0002.30	1361	N/A	N/A
Test Software	TESEQ	HVM 3060_0002.30	293	N/A	N/A

- NOTE:** 1. The test was performed in EMS Room 1.
2. The calibration interval of the above test instruments is 12 months and the calibrations are traceable to CEPREI/CHINA, GRGT/CHINA and NIM/CHINA.



4.5.3 TEST PROCEDURE

a. For EUT power supply:

The surge is to be applied to the EUT power supply terminals via the capacitive coupling network. Decoupling networks are required in order to avoid possible adverse effects on equipment not under test that may be powered by the same lines, and to provide sufficient decoupling impedance to the surge wave. The power cord between the EUT and the coupling/decoupling networks shall be 2 meters in length (or shorter).

b. For test applied to unshielded unsymmetrically operated interconnection lines of EUT:

The surge is applied to the lines via the capacitive coupling. The coupling / decoupling networks shall not influence the specified functional conditions of the EUT. The interconnection line between the EUT and the coupling/decoupling networks shall be 2 meters in length (or shorter).

c. For test applied to unshielded symmetrically operated interconnection / telecommunication lines of EUT:

The surge is applied to the lines via gas arrestors coupling. Test levels below the ignition point of the coupling arrestor cannot be specified. The interconnection line between the EUT and the coupling/decoupling networks shall be 2 meters in length (or shorter).

4.5.4 DEVIATION FROM TEST STANDARD

No deviation.

4.5.5 TEST SETUP

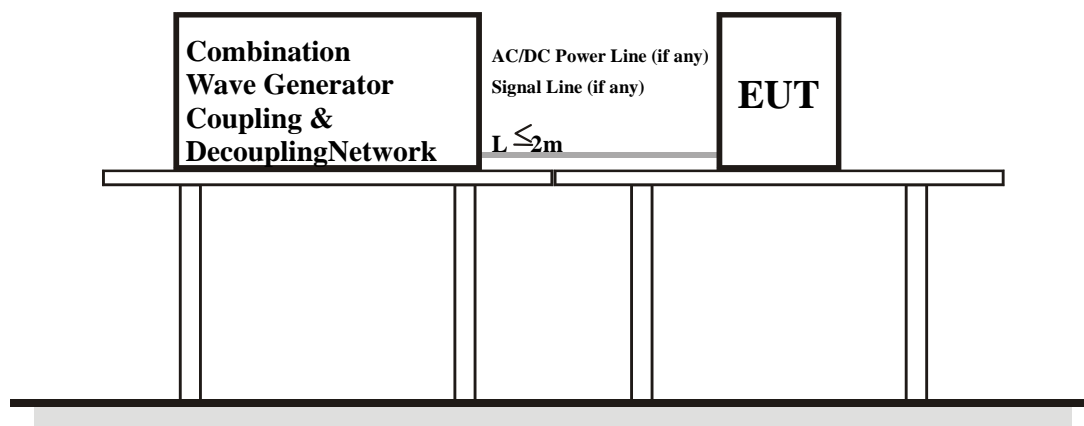



4.5.6 TEST RESULTS

TEST MODE	See item 2.2	TEST VOLTAGE	DC 300V
ENVIRONMENTAL CONDITIONS	21.5deg. C, 59.2% RH	TESTED BY: Heise	

AC/DC Power port:

\Phase angle \ Test result			0°	90°	180°	270°	DC Power Port
Voltage (kV)	\ Test point	Polarity					
1	L-N	+	B	B	B	B	N/A
		-	B	B	B	B	N/A
2	L-PE	+	B	B	B	B	N/A
		-	B	B	B	B	N/A
2	N-PE	+	B	B	B	B	N/A
		-	B	B	B	B	N/A

Signal ports and telecommunication ports:

Voltage (kV)	Test Point	Polarity	Test result	Voltage (kV)	Test Point	Polarity	Test result
/	/	+/-	/	/	/	+/-	/

NOTE: A: There was no change compared with initial operation during the test.

B: During test, EUT stopped grid, and could automatically return to normal after test.



4.6 IMMUNITY TO CONDUCTED DISTURBANCES INDUCED BY RF FIELDS (CS)

4.6.1 TEST SPECIFICATION

Basic Standard:	IEC 61000-4-6
Frequency Range:	0.15 MHz - 80 MHz
Field Strength:	10V _{r.m.s}
Modulation:	1kHz Sine Wave, 80%, AM Modulation
Frequency Step:	1 % of fundamental
Coupled Cable:	Power Mains & DC Power Line
Coupling Device:	CDN-M3(3 wires) & Clamp

4.6.2 TEST INSTRUMENTS

Equipment	Manufacturer	Model No.	Serial No.	Last Cal.	Next Cal.
Signal Generator	Rohde&Schwarz	SME06	829498/006	Oct.15,13	Oct.14, 14
CDN	Luthi	L-801M2/M3	2015	Oct.18,13	Oct. 17,14
CDN(AUX)	TESEQ	CDN M016	27452	Nov. 20,13	Nov. 19,14
CDN	TESEQ	T200A	26944	Apr. 08,14	Apr. 07,15
CDN	TESEQ	T400A	26536	Apr. 08,14	Apr. 07,15
CDN	TESEQ	ST08A	32256	Apr. 08,14	Apr. 07,15
6dB 50Watt Attenuator	HUBER+SUHNER	5906.17.0005	303688	Oct.15,13	Oct.14,14
Signal Amplifier	HAEFELY	PAMP250	149594	NA	NA
Electromagnetic Injection Clamp	Luthi	EM101	35640	Oct.16,13	Oct.15,14
C/S Test System	HAEFELY	WinPAMP	NSEMC002	N/A	N/A
Test Software	ADT	BVADT_CS_V7.5.1	N/A	N/A	N/A

- NOTE:**
1. The test was performed in CS test room.
 2. The calibration interval of the above test instruments is 12 months and the calibrations are traceable to CEPREI/CHINA, GRGT/CHINA and NIM/CHINA.



4.6.3 TEST PROCEDURE

- a. The EUT shall be tested within its intended operating and climatic conditions.
- b. An artificial hand was placed on the hand-held accessory and connected to the ground reference plane.
- c. The test shall be performed with the test generator connected to each of the coupling and decoupling devices in turn, while the other non-excited RF input ports of the coupling devices are terminated by a 50-ohm load resistor.
- d. The frequency range is swept from 150 kHz to 80 MHz, using the signal level established during the setting process and with a disturbance signal of 80 % amplitude. The signal is modulated with a 1 kHz sine wave, pausing to adjust the RF signal level or the switch coupling devices as necessary. Where the frequency is swept incrementally, the step size shall not exceed 1 % of the preceding frequency value.
- e. The dwell time of the amplitude modulated carrier at each frequency shall not be less than the time necessary for the EUT to be exercised and to respond, but shall in no case be less than 0,5 s. The sensitive frequencies (e.g. clock frequencies) shall be analyzed separately.
- f. Attempts should be made to fully exercise the EUT during testing, and to fully interrogate all exercise modes selected for susceptibility.

4.6.4 DEVIATION FROM TEST STANDARD

No deviation.



4.6.5 TEST SETUP

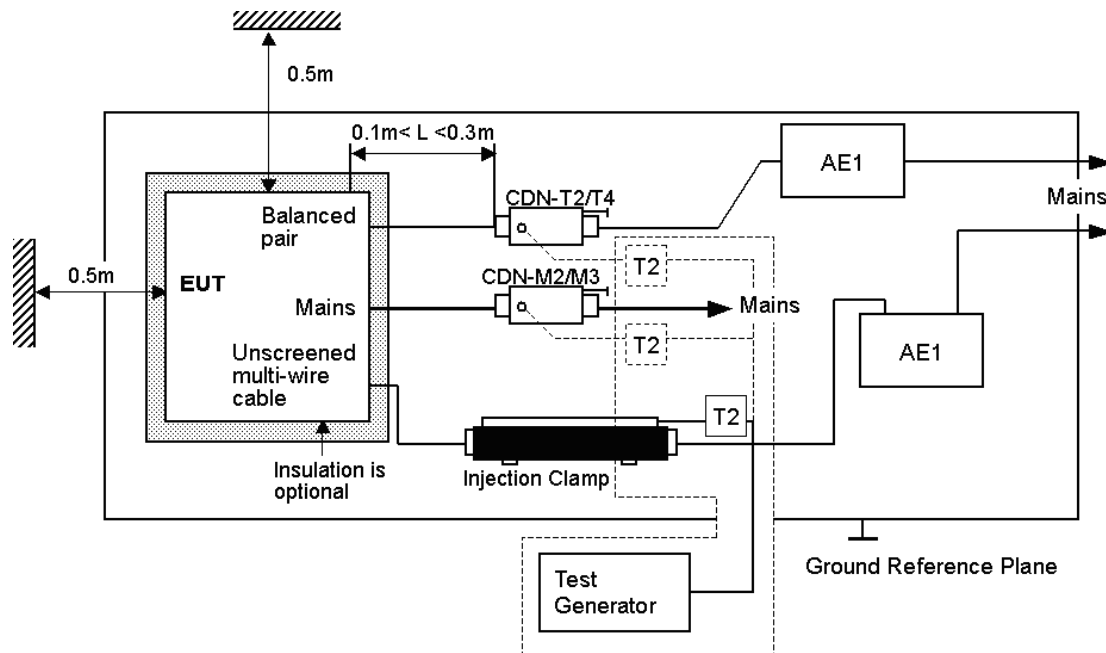

NOTE: The EUT clearance from any metallic obstacles shall be at least 0.5m.
All non-excited input ports of the CDNs shall be terminated by 50Ω loads.

NOTE:

FLOOR-STANDING EQUIPMENT

The equipment to be tested is placed on an insulating support of 0.1 meters height above a ground reference plane. All relevant cables shall be provided with the appropriate coupling and decoupling devices at a distance between 0.1 meters and 0.3 meters from the projected geometry of the EUT on the ground reference plane.



4.6.6 TEST RESULTS

TEST MODE	See Item 2.2	TEST VOLTAGE	DC 300V
ENVIRONMENTAL CONDITIONS	22.5deg. C, 56.6% RH	TESTED BY: Heise	

Voltage (V)	Test Frequency Note ^{#1} (MHz)	Tested Line	Injection Method.	Test Result	Remark
10	0.15 – 80	AC Mains	CDN-M3	A	N/A
10	0.15 – 80	DC line	Clamp	A	N/A

Note^{#1}: Tested Israel SII Frequencies 0.2,0.53,1,1.5,7.1,13.56,21,27.12,40.68,65,68 MHz

NOTE: A: There was no change compared with initial operation during the test.



4.7 POWER FREQUENCY MAGNETIC FIELD IMMUNITY TEST

4.7.1 TEST SPECIFICATION

Basic Standard:	IEC 61000-4-8
Frequency Range:	50Hz, 60Hz
Field Strength:	30A/m
Observation Time:	5 minute
Inductance Coil:	Rectangular type, 1mx1m

4.7.2 TEST INSTRUMENTS

Equipment	Manufacturer	Model No.	Serial No.	Last Cal.	Next Cal.
Magnetic Field Tester	HAEFELY	MAG100.1	150579	Oct.18,13	Oct.17,14
Test Software	N/A	N/A	N/A	N/A	N/A

- NOTE:** 1. The test was performed in Shielding Room 843.
2. The calibration interval of the above test instruments is 12 months and the calibrations are traceable to CEPREI/CHINA, GRGT/CHINA and NIM/CHINA.

4.7.3 TEST PROCEDURE

- The equipment is configured and connected to satisfy its functional requirements.
- The power supply, input and output circuits shall be connected to the sources of power supply, control and signal.
- The cables supplied or recommended by the equipment manufacturer shall be used. 1 meter of all cables used shall be exposed to the magnetic field.

4.7.4 DEVIATION FROM TEST STANDARD

No Deviation



4.7.5 TEST SETUP

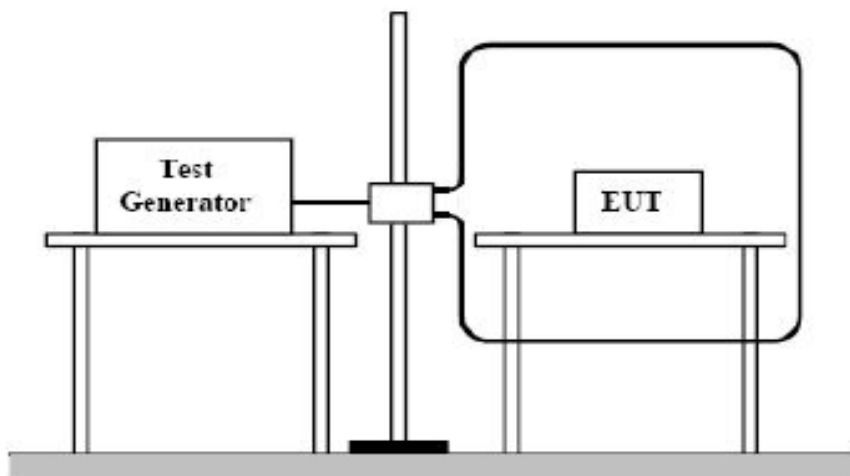

NOTE:

TABLETOP EQUIPMENT

The equipment shall be subjected to the test magnetic field by using the induction coil of standard dimension (1 m x 1 m). The induction coil shall then be rotated by 90 degrees in order to expose the EUT to the test field with different orientations.

FLOOR-STANDING EQUIPMENT

The equipment shall be subjected to the test magnetic field by using induction coils of suitable dimensions. The test shall be repeated by moving and shifting the induction coils, in order to test the whole volume of the EUT for each orthogonal direction. The test shall be repeated with the coil shifted to different positions along the side of the EUT, in steps corresponding to 50 % of the shortest side of the coil. The induction coil shall then be rotated by 90 degrees in order to expose the EUT to the test field with different orientations.



4.7.6 TEST RESULTS

TEST MODE	See Item 2.2	TEST VOLTAGE	DC 300V
ENVIRONMENTAL CONDITIONS	22deg. C, 59% RH	TESTED BY: Heise	

MAGNETIC FIELD DIRECTION	TESTING RESULT	REMARK
X - Axis	A	30A/ m
Y - Axis	A	30A/ m
Z - Axis	A	30A/ m

NOTE: A: There is no change compared with the initial operation during the test.



5 PHOTOGRAPHS OF THE TEST CONFIGURATION

CONDUCTED EMISSION TEST





RADIATED EMISSION TEST

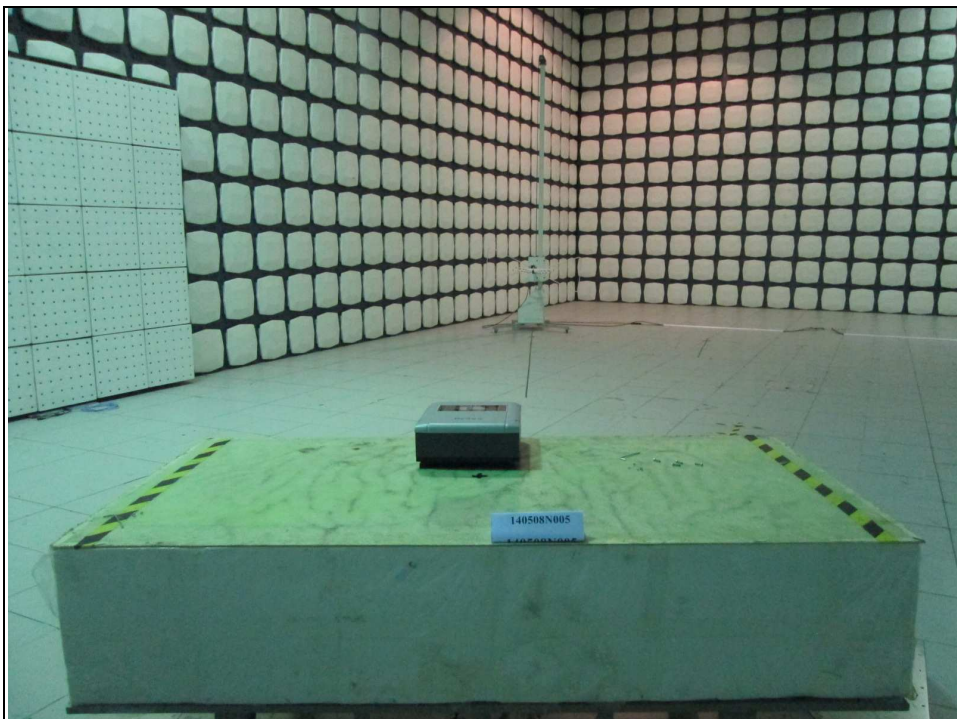
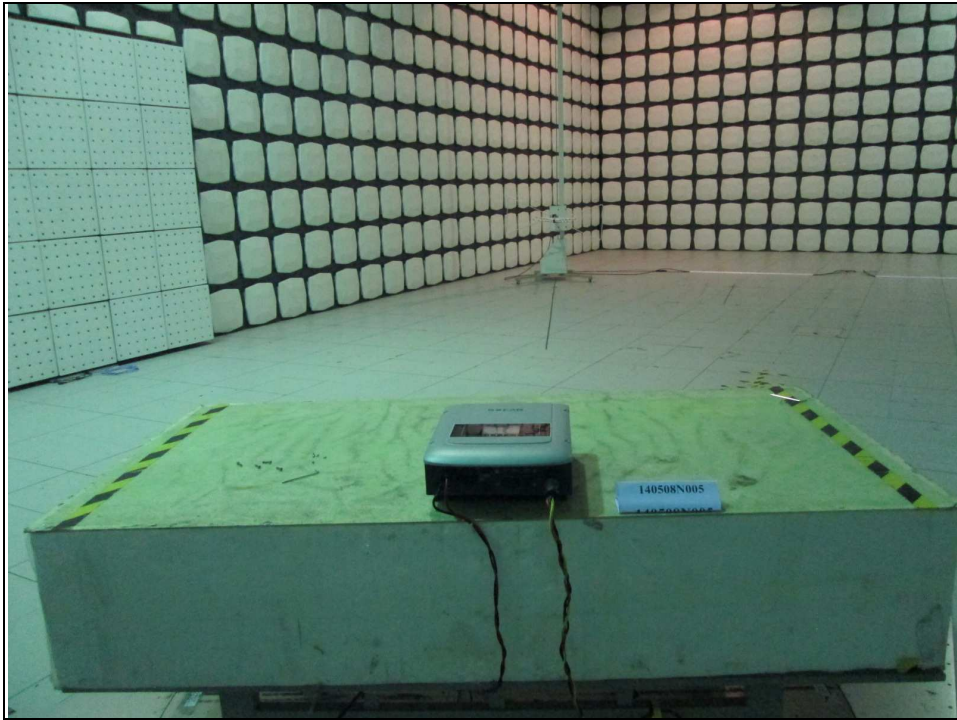

HARMONICS EMISSION TEST &
VOLTAGE FLUCTUATIONS AND FLICKER TEST



ESD TEST



RS TEST

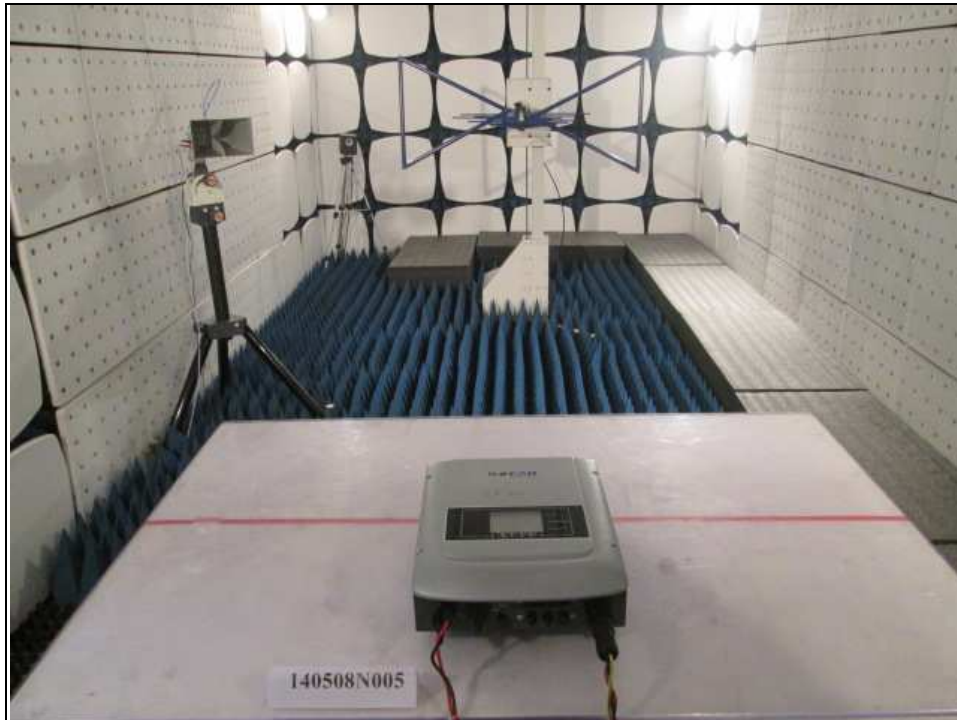

EFT TEST(AC Mains)





EFT TEST (DC Port)



SURGE TEST



CONDUCTED SUSCEPTIBILITY TEST (AC Mains)



CONDUCTED SUSCEPTIBILITY TEST (DC Cable)





**BUREAU
VERITAS**

Test Report No.: CE140508N005R1

POWER-FREQUENCY MAGNETIC FIELDS TEST





Test Report No.: CE140508N005R1

6 APPENDIX A – MODIFICATIONS RECORDERS FOR ENGINEERING CHANGES TO THE EUT BY THE LAB

No any modifications were made to the EUT by the lab during the test.

---END---